ACCESS SERVICE

2. General Regulations**2.1 Undertaking of the Telephone Company****2.1.1 Scope**

- (A) The Telephone Company does not undertake to transmit messages under this tariff.
- (B) The Telephone Company shall be responsible only for the installation, operation and maintenance of the services it provides.
- (C) The Telephone Company will, for maintenance purposes, test its services only to the extent necessary to detect and/or clear troubles.
- (D) Services are provided 24 hours daily, seven days per week, except as set forth in other applicable sections of this tariff.
- (E) The Telephone Company does not warrant that its facilities and services meet standards other than those set forth in this tariff.

2.1.2 Limitations

- (A) The customer may not assign or transfer the use of services provided under this tariff; however, where there is no interruption of use or relocation of the services, such assignment or transfer may be made to:
 - (1) another customer, whether an individual, partnership, association or corporation, provided the assignee or transferee assumes all outstanding indebtedness for such services, and the unexpired portion of the minimum period and the termination liability applicable to such services, if any; or

ACCESS SERVICE

2. General Regulations (Cont'd)**2.1 Undertaking of the Telephone Company (Cont'd)****2.1.2 Limitations (Cont'd)****(A) (Cont'd)**

- (2) a court-appointed receiver, trustee or other person acting pursuant to law in bankruptcy, receivership, reorganization, insolvency, liquidation or other similar proceedings, provided the assignee or transferee assumes the unexpired portion of the minimum period and the termination liability applicable to such services, if any.

In all cases of assignment or transfer, the written acknowledgment of the Telephone Company is required prior to such assignment or transfer which acknowledgment shall be made within 15 days from the receipt of notification. All rates, regulations and conditions contained in this tariff shall apply to such assignee or transferee.

The assignment or transfer of services does not relieve or discharge the assignor or transferor from remaining jointly or severally liable with the assignee or transferee for any obligation existing at the time of the assignment or transfer.

- (B) The regulations for the restoration and installation of Telecommunications Service Priority (TSP) System services shall be in accordance with Part 64, Subpart D, Appendix A, of the Federal Communications Commission's Rules and Regulations and Section 8.8 following.

- (C) Subject to compliance with the rules mentioned in (B) preceding, the services offered herein will be provided to customers on a first-come, first-served basis, except as outlined in (D) following.

- (D) When an end office is scheduled to be converted to an equal access end office, and a shortage of facilities exists, the Telephone Company will allocate available resources to participating ICs as set forth in 5.1.5(A) following.

ACCESS SERVICE

2. General Regulations (Cont'd)**2.1 Undertaking of the Telephone Company (Cont'd)****2.1.3 Liability**

- (A) The Telephone Company's liability, if any, for its willful misconduct is not limited by this tariff. With respect to any other claim or suit, by a customer or by any others, for damages associated with the installation, provision, preemption, termination, maintenance, repair or restoration, of service, and subject to the provisions of (B) through (H) following, the Telephone Company's liability if any, shall not exceed an amount equal to the proportionate charge for the service for the period during which the service was affected. This liability for damages shall be in addition to any amounts that may otherwise be due the customer under this tariff as a Credit Allowance for a Service Interruption.
- (B) The Telephone Company shall not be liable for any act or omission of any other carrier or customer providing a portion of a service, nor shall the Telephone Company for its own act or omission hold liable any other carrier or customer providing a portion of a service.
- (C) The Telephone Company is not liable for damages to the customer premises resulting from the furnishing of a service, including the installation and removal of equipment and associated wiring, unless the damage is caused by the Telephone Company's negligence.
- (D) The Telephone Company shall be indemnified, defended and held harmless by the customer against any claim, loss or damage arising from the customer's use of services offered under this tariff, involving:
- (1) Claims for libel, slander, invasion of privacy, or infringement of copyright arising from the customer's own communications.

ACCESS SERVICE

2. General Regulations (Cont'd)**2.1 Undertaking of the Telephone Company (Cont'd)****2.1.3 Liability (Cont'd)****(D) (Cont'd)**

(2) Claims for patent infringement arising from the customer's acts combining or using the service furnished by the Telephone Company in connection with facilities or equipment furnished by the customer or;

(3) All other claims arising out of any act or omission of the customer in the course of using services provided pursuant to this tariff.

(E) The Telephone Company does not guarantee or make any warranty with respect to its services when used in an explosive atmosphere. The Telephone Company shall be indemnified, defended and held harmless by the customer from any and all claims by any person relating to such customer's use of services so provided.

(F) No license under patents (other than the limited license to use) is granted by the Telephone Company or shall be implied or arise by estoppel, with respect to any service offered under this tariff.

(G) The Telephone Company's failure to provide or maintain services under this tariff shall be excused by labor difficulties, governmental orders, civil commotions, criminal actions taken against the Telephone Company, acts of God and other circumstances beyond the Telephone Company's reasonable control, subject to the Credit Allowance for a Service Interruption as set forth in 2.4.4 following.

ACCESS SERVICE

2. General Regulations (Cont'd)**2.1 Undertaking of the Telephone Company (Cont'd)****2.1.4 Provision of Services**

The Telephone Company, to the extent that such services are or can be made available with reasonable effort, and after provision has been made for the Telephone Company's telephone exchange services, will provide to the customer upon reasonable notice services offered in other applicable sections of this tariff at rates and charges specified therein.

2.1.5 Installation and Termination of Services

Except as provided for Expanded Interconnection Service specified in Section 17, the services provided under this tariff (A) will include any entrance cable or drop wiring and wire or intrabuilding cable to that point where provision is made for termination of the Telephone Company's outside distribution network facilities at a location at the customer-designated premises and (B) will be installed by the Telephone Company to such Point of Termination. The Telephone Company will work cooperatively with the customer to determine the location of the Point of Termination in accordance with the Telephone Company's standard operating procedures.

Each Access Service has only one Point of Termination per customer premises. Any additional terminations beyond such Point of Termination are the sole responsibility of the customer. Moves of the Point of Termination are handled as set forth in 6.5.4(C) and 7.2.1(D)(3).

2.1.6 Maintenance of Services

(A) The services provided under this tariff shall be maintained by the Telephone Company. The customer or others may not rearrange, move, disconnect, remove or attempt to repair any facilities provided by the Telephone Company, other than by connection or disconnection to any interface means used, except with the written consent of the Telephone Company.

(B) Customer provided transmission facilities and equipment terminating in the Telephone Company wire center or Telephone Company access tandem for purposes of physical Expanded Interconnection Service (EIS), as set forth in Section 17, will not be maintained by the Telephone Company. Customer provided facilities and equipment terminating in Telephone Company manhole or similar location for virtual EIS will be maintained by the Telephone Company.

ACCESS SERVICE

2. General Regulations (Cont'd)**2.1 Undertaking of the Telephone Company (Cont'd)****2.1.7 Changes, Substitutions and Rearrangements**

Except as provided for equipment and systems subject to FCC Part 68 Regulations at 47 C.F.R Section 68.110(b), the Telephone Company may, where such action is reasonably required in the operation of its business;

- (A) Substitute, change or rearrange any facilities used in providing service under this tariff, including but not limited to;
- (1) substitution of different metallic facilities,
 - (2) substitution of carrier or derived facilities for metallic facilities used to provide other than metallic facilities, and
 - (3) substitution of metallic facilities for carrier or derived facilities used to provide other than metallic facilities; and
 - (4) change in the routing of access service traffic.
- (B) Change minimum protection criteria;
- (C) Change operating or maintenance characteristics of facilities or,
- (D) Change operations or procedures of the Telephone Company.

In case of any such substitution, change or rearrangement, the transmission parameters will be within the range as set forth in 6., 7. and 9. following. The Telephone Company shall not be responsible if any such substitution, change or rearrangement renders any customer furnished services obsolete or requires modification or alteration thereof or otherwise affects their use or performance. If such substitution, change or rearrangement materially affects the operating characteristics of the facility, the Telephone Company will provide reasonable notification to the customer in writing. Reasonable time will be allowed for any redesign and implementation required by the change in operating characteristics. The Telephone Company will work cooperatively with the customer to determine reasonable notification procedures.

ACCESS SERVICE

2. General Regulations (Cont'd)**2.1 Undertaking of the Telephone Company (Cont'd)****2.1.8 Refusal and Discontinuance of Service**

(A) Unless the provisions of 2.2.1(B) or 2.5.1 following apply, if a customer fails to comply with the regulations set forth in: 2.1.6, Maintenance of Service; 2.2.2, Unlawful Use; 2.3.1, Damages; 2.3.4, Availability for Testing; 2.3.5, Balance; and 2.4, Payment Arrangements and Credit Allowances or, if applicable, 2.5.3, 2.5.4, 17.3.4 and 17.7.6(D), Expanded Interconnection Service (EIS) or fails to make any payment to be made by it on the dates and times herein specified, the Telephone Company may, on thirty (30) days written notice by Certified U.S. Mail or Overnight Delivery to the person designated by that customer to receive such notices of noncompliance:

- (1) Refuse additional applications for service and/or refuse to complete any pending orders for service by the non-complying customer; and/or
- (2) Discontinue the provision of the services to the noncomplying customer. In the case of such discontinuance, all applicable charges including termination charges shall become due.

If the Telephone Company does not refuse additional applications for service on the date specified in the thirty (30) days notice given pursuant to (1) above, or does not discontinue its provision of services involved on the date specified in the thirty (30) day notice given pursuant to (2) above and the customer's noncompliance continues, nothing contained herein shall preclude the Telephone Company's right to refuse additional applications for service to the non-complying customer without further notice.

- (3) In addition to and not in limitation of the provisions of section 2.1.8(A) preceding, unless the provisions of 2.2.1(B) or 2.5.1 following apply, if a customer fails to comply with 2.4.1(B)(3) or with 2.4.1(A) following, including any bill payments to be made by it on the dates and times herein specified, the Telephone Company may take the actions specified in sections 2.1.8(A)(1) and 2.8.1(A)(2) with regard to services provided hereunder to that customer on fifteen (15) calendar days written notice, such notice period to start the day after the notice is sent by Overnight Delivery, if the customer has not complied with respect to amounts due in a subject bill and either:
 - (a) the Telephone Company has sent the subject bill to the customer within seven (7) business days from the bill date, or
 - (b) the Telephone Company has sent the subject bill to the customer more than thirty (30) calendar days before the notice under this section is given.

In all other cases, the Telephone Company will give thirty (30) calendar days written notice pursuant to sections 2.1.8(A). The Telephone Company will maintain records sufficient to validate the date upon which a bill was sent to a customer. Action will not be taken as specified in 2.1.8(A)(1) and 2.8.1(A)(2) with regard to the subject bill if the customer cures the noncompliance prior to the expiration of the fifteen (15) or thirty (30) days notice period, as applicable.

If the Telephone Company does not refuse additional applications for service on the date specified in the fifteen (15) days notice given pursuant to (3) above, or does not discontinue its provision of services involved on the date specified in the fifteen (15) day notice given pursuant to (3) above and the customer's noncompliance continues, nothing contained herein shall preclude the Telephone Company's right to refuse additional applications for service to the non-complying customer without further notice.

- (4) If notice is given by Overnight Delivery under this section, it shall be performed by a reputable overnight delivery service such as, or comparable to, the U.S. Postal Service Express Mail, United Parcel Service, or Federal Express.
- (5) The Provisions of section 2.1.8(A)(1), (2), and (3) shall not apply to charges that a customer does not pay based on submission of a good faith dispute pursuant to section 2.4.1(D)(1).

ACCESS SERVICE

2. General Regulations (Cont'd)**2.1 Undertaking of the Telephone Company (Cont'd)****2.1.8 Refusal and Discontinuance of Service (Cont'd)**

- (B) When access service is provided by more than one Telephone Company, the Companies involved in providing the joint service may individually or collectively deny service to a customer for nonpayment. Where the Telephone Company(s) affected by the nonpayment is incapable of effecting discontinuance of service without cooperation from the other joint providers of Switched Access Service, such other Telephone Company(s) will, if technically feasible, assist in denying the joint service to the customer. Service denial for such joint service will only include calls originating or terminating within, or transiting, the operating territory of the Telephone Companies initiating the service denial for nonpayment. When more than one of the joint providers must deny service to effectuate termination for nonpayment in cases where a conflict exists in the applicable tariff provisions, the tariff regulations of the end office Telephone Company shall apply for joint service discontinuance.

ACCESS SERVICE

2. General Regulations (Cont'd)**2.1 Undertaking of the Telephone Company (Cont'd)****2.1.9 Limitation of Use of Metallic Facilities**

Signals applied to a metallic facility shall conform to the limitations set forth in Technical Reference PUB AS No. 1, Issue II. In the case of applications of dc telegraph signaling systems, the customer shall be responsible, at its expense, for the provision of current limiting devices to protect the Telephone Company facilities from excessive current due to abnormal conditions and for the provision of noise mitigation networks when required to reduce excessive noise.

2.1.10 Notification of Service-Affecting Activities

The Telephone Company will provide the customer reasonable notification of service-affecting activities that may occur in normal operation of its business. Such activities may include, but are not limited to, equipment or facilities additions, removals or rearrangements, routine preventative maintenance and major switching machine change-out. Generally, such activities are not individual customer service specific, they affect many customer services. No specific advance notification period is applicable to all service-affecting activities. The Telephone Company will work cooperatively with the customer to determine the notification requirements.

2.1.11 Coordination with Respect to Network Contingencies

The Telephone Company intends to work cooperatively with the customer to develop network contingency plans in order to maintain maximum network capability following natural or man-made disasters which affect telecommunications services.

2.1.12 Provision and Ownership of Telephone Numbers

The Telephone Company reserves the reasonable right to assign, designate or change telephone numbers, any other call number designations associated with Access Services, or the Telephone Company serving central office prefixes associated with such numbers, when necessary in the conduct of its business. Should it become necessary to make a change in such number(s), the Telephone Company will furnish to the customer 6 months notice, by Certified U.S. Mail, of the effective date and an explanation of the reason(s) for such change(s).

ACCESS SERVICE

2. General Regulations (Cont'd)**2.2 Use****2.2.1 Interference or Impairment**

(A) The characteristics and methods of operation of any circuits, facilities or equipment provided by other than the Telephone Company, including customer transmission equipment and facilities used with Expanded Interconnection Services, and associated with the facilities utilized to provide services under this tariff shall not interfere with or impair service over any facilities of the Telephone Company, its affiliated companies, or its connecting and concurring carriers involved in its services, cause damage to their plant, impair the privacy of any communications carried over their facilities or create hazards to the employees of any of them or the public.

(B) Except as provided for equipment or systems subject to the FCC Part 68 Rules in 47 C.F.R Section 68.108, if such characteristics or methods of operation are not in accordance with (A) preceding, the Telephone Company will, where practicable, notify the customer that temporary discontinuance of the use of a service may be required; however, where prior notice is not practicable, nothing contained herein shall be deemed to preclude the Telephone Company's right to temporarily discontinue forthwith the use of a service if such action is reasonable under the circumstances. In case of such temporary discontinuance, the customer will be promptly notified and afforded the opportunity to correct the condition which gave rise to the temporary discontinuance. During such period of temporary discontinuance, credits as set forth in Section 2.7 following, are not applicable.

Unlawful Use**2.2.2**

The service provided under this tariff shall not be used for an unlawful purpose.

Commingling**2.2.3**

Except as provided in Section 51.318 of the Federal Communications Commission's rules, telecommunications carriers who obtain unbundled network elements or combinations of unbundled network elements pursuant to a Statement of Generally Available Terms, under Section 252 of the Act, or pursuant to an interconnection agreement with the Telephone Company, may connect, combine, or otherwise attach such unbundled network elements or combinations of unbundled network elements to access services purchased under this tariff except to the extent such agreement (1) expressly prohibits such commingling; or (2) does not address commingling and the requesting carrier has not negotiated an interconnection agreement (or amendment) expressly permitting such commingling. The rates, terms, and conditions of this tariff will apply to the access services that are commingled. Unbundled network elements or combinations of unbundled network elements that are commingled with access services do not constitute a shared use arrangement as set forth in this tariff, and are therefore not eligible for adjustment of charges under such provisions.

ACCESS SERVICE

2. General Regulations (Cont'd)**2.3 Obligations of the Customer****2.3.1 Damages**

The customer shall reimburse the Telephone Company for damages to Telephone Company facilities utilized to provide services under this tariff caused by the negligence or willful act of the customer, or resulting from the customer's improper use of the Telephone Company facilities, or due to malfunction of any facilities or equipment provided by other than the Telephone Company. Nothing in the foregoing provision shall be interpreted to hold one customer liable for another customer's actions. The Telephone Company will, upon reimbursement for damages, cooperate with the customer in prosecuting a claim against the person causing such damage and the customer shall be subrogated to the right of recovery by the Telephone Company for the damages to the extent of such payment.

2.3.2 Ownership of Facilities and Theft

Facilities utilized by the Telephone Company to provide service under the provisions of this tariff shall remain the property of the Telephone Company. Such facilities shall be returned to the Telephone Company by the customer, whenever requested, within a reasonable period following the request in as good condition as reasonable wear will permit.

2.3.3 Equipment Space and Power

(A) Except as specified in (B), the customer shall furnish or arrange to have furnished to the Telephone Company, at no charge, equipment space and electrical power required by the Telephone Company to provide services under this tariff at the points of termination of such services. The selection of ac or dc power shall be mutually agreed to by the customer and the Telephone Company. The customer shall also make necessary arrangements in order that the Telephone Company will have access to such spaces at reasonable times for installing, testing, repairing or removing Telephone Company services.

(B) Where available, the Telephone Company shall make available wire center or Telephone Company access tandem floor space and electrical power by the customer for the provision of Expanded Interconnection Service at charges set forth in Section 17.

ACCESS SERVICE

2. General Regulations (Cont'd)**2.3 Obligations of the Customer (Cont'd)****2.3.4 Availability for Testing**

The services provided under this tariff shall be available to the Telephone Company at times mutually agreed upon in order to permit the Telephone Company to make tests and adjustments appropriate for maintaining the services in satisfactory operating condition. Such tests and adjustments shall be completed within a reasonable time. No credit will be allowed for any interruptions involved during such tests and adjustments.

2.3.5 Balance

All signals for transmission over the services provided under this tariff shall be delivered by the customer balanced to ground except for ground start, duplex (DX) and McCulloh-Loop (Alarm System) type signaling and dc telegraph transmission at speeds of 75 baud or less.

2.3.6 Design of Customer Services

Subject to the provisions of 2.1.7 preceding, the customer shall be solely responsible, at its own expense, for the overall design of its services and for any redesigning or rearrangement of its services which may be required because of changes in facilities, operations or procedures of the Telephone Company, minimum protection criteria or operating or maintenance characteristics of the facilities.

2.3.7 References to the Telephone Company

The customer may advise End Users that certain services are provided by the Telephone Company in connection with the service the customer furnishes to End Users; however, the customer shall not represent that the Telephone Company jointly participates in the customer's services.

2.3.8 Claims and Demands for Damages

(A) With respect to claims of patent infringement made by third persons, the customer shall defend, indemnify, protect and save harmless the Telephone Company from and against all claims arising out of the combining with, or use in connection with, the services provided under this tariff, any circuit, apparatus, system or method provided by the customer.

ACCESS SERVICE

2. General Regulations (Cont'd)**2.3 Obligations of the Customer (Cont'd)****2.3.8 Claims and Demands for Damages (Cont'd)**

(B) The customer shall defend, indemnify and save harmless the Telephone Company from and against any suits, claims, losses or damages, including punitive damages, attorney fees and court costs by third persons arising out of the construction, installation, operation, maintenance, or removal of the customer's circuits, facilities, or equipment connected to the Telephone Company's services provided under this tariff, including, without limitation, Workmen's Compensation claims, actions for infringement of copyright and/or unauthorized use of program material, libel and slander actions based on the content of communications transmitted over the customer's circuits, facilities or equipment, and proceedings to recover taxes, fines, or penalties for failure of the customer to obtain or maintain in effect any necessary certificates, permits, licenses, or other authority to acquire or operate the services provided under this tariff; provided, however, the foregoing indemnification shall not apply to suits, claims, and demands to recover damages for damage to property, death, or personal injury unless such suits, claims or demands are based on the tortuous conduct of the customer, its officers, agents or employees.

(C) The customer shall defend, indemnify and save harmless the Telephone Company from and against any suits, claims, losses or damages, including punitive damages, attorney fees and court costs by the customer or third parties arising out of any act or omission of the customer in the course of using services provided under this tariff.

2.3.9 Coordination with Respect to Network Contingencies

The customer shall, in cooperation with the Telephone Company, coordinate in planning the actions to be taken to maintain maximum network capability following natural or man-made disasters which affect telecommunications services.

2.3.10 Sectionalization and Trouble Reporting

The customer will be responsible for reporting troubles sectionalized to Telephone Company facilities and/or equipment. When trouble cannot be clearly sectionalized to the Telephone Company facilities and/or equipment, the Telephone Company will test cooperatively or independently to assist in trouble sectionalization.

ACCESS SERVICE

2. General Regulations (Cont'd)2.3 Obligations of the Customer (Cont'd)2.3.11 Identification and Rating of VoIP-PSTN Traffic

(N)

(A) Scope

VoIP-PSTN Traffic is defined as traffic exchanged between the Telephone Company end user and the customer in time division multiplexing ("TDM") format that originates and/or terminates in Internet protocol ("IP") format. This section governs the identification of VoIP-PSTN Traffic that is required to be compensated at interstate access rates by the Federal Communications Commission in its Report and Order in WC Docket Nos. 10-90, etc., FCC Release No. 11-161 (Nov. 18, 2011) ("FCC Order"). Specifically, this section establishes the method of separating VoIP-PSTN Traffic from the customer's traditional intrastate access traffic, so that such VoIP-PSTN Traffic can be billed in accordance with the FCC Order.

(B) Rating of VoIP-PSTN Traffic

Interstate and Intrastate VoIP-PSTN Traffic identified in accordance with this tariff section will be billed at rates equal to the Telephone Company's applicable tariffed interstate switched access rates as specified in Section 6 following.

(C) Calculation and Application of Percent-VoIP-Usage Factor

The Telephone Company will determine the number of VoIP-PSTN Traffic minutes of use ("MOU") to which interstate rates will be applied under subsection (B), above, by applying a Percent VoIP Usage ("PVU") factor to the total terminating intrastate access MOU received by The Telephone Company from the customer. The PVU will be derived and applied as follows:

- (1) The customer will calculate and furnish to the Telephone Company a factor (the "PVU") representing the percentage of the total intrastate and interstate access MOU that the customer terminates to the Telephone Company in the State, that is sent to the Telephone Company and that originated in IP format. This PVU shall be based on information such as traffic studies, actual call detail, or other relevant and verifiable information. The customer shall retain the call detail, work papers, and information used to develop the PVU factor for a minimum of one year
- (2) The customer shall not modify their reported PIU factor to account for VoIP-PSTN Traffic.
- (3) The Telephone Company will apply the PVU factor to the total terminating intrastate access MOU received from the customer to determine the number of VoIP-PSTN Traffic MOUs.
- (4) If the customer does not furnish the Telephone Company with a PVU pursuant to the preceding paragraph 1, the Telephone Company will utilize a PVU equal to zero.

(N)

ACCESS SERVICE

2. General Regulations (Cont'd)2.3 Obligations of the Customer (Cont'd)2.3.11 Identification and Rating of VoIP-PSTN Traffic (Cont'd)

(N)

(D) Initial PVU Factor

If the PVU factor is not available and/or cannot be implemented in the Telephone Company's billing systems by December 31, 2011, once the factor is available and can be implemented the Telephone Company will adjust the customer's bills to reflect the PVU retroactively to December 31, 2011. This retroactive adjustment will be made to December 31, 2011, provided that the customer provides the factor to the Telephone Company no later than April 15, 2012; otherwise, it will set the initial PVU equal to zero, as specified in subsection (C)(4), above.

The Telephone Company may choose to provide credits based on the reported PVU factors until such time as billing system modifications can be implemented.

(E) PVU Factor Updates

The customer may update the PVU factor quarterly using the method set forth in subsection (C)(1), above. If the customer chooses to submit such updates, it shall forward to the Telephone Company, no later than 15 days after the first day of January, April, July and/or October of each year, a revised PVU factor based on data for the prior three months, ending the last day of December, March, June and September, respectively. The revised PVU factor will apply prospectively and serve as the basis for billing until superseded by a new PVU. No prorating or back billing will be done based on the updated PVU factor.

(F) PVU Factor Verification

(1) Not more than four times in any year, the Telephone Company may request from the customer an overview of the process used to determine the PVU factors, the call detail records, description of the method for determining how the end user originates or terminates calls in IP format, and other information used to determine the customer's PVU factor furnished to the Telephone Company in order to validate the PVU factor supplied. The customer shall comply, and shall reasonably supply the requested data and information within 15 days of the Telephone Company's request.

(2) The Telephone Company may dispute the customer's PVU factor based upon:

(a) A review of the requested data and information provided by the customer.

(b) The Telephone Company's reasonable review of other market information, FCC reports on VoIP lines, such as FCC Form 477 or state level results based on FCC Local Competition Report or other relevant data.

(c) A change in the reported PVU factor by more than five percentage points from the preceding quarter.

(N)

ACCESS SERVICE

-
2. General Regulations (Cont'd)
- 2.3 Obligations of the Customer (Cont'd)
- 2.3.11 Identification and Rating of VoIP-PSTN Traffic (Cont'd) (N)
- (F) PVU Factor Verification (Cont'd)
- (3) If after review of the data and information, the customer and the Telephone Company establish a revised PVU factor, the customer and the Telephone Company will begin using that revised PVU factor with the next bill period.
- (4) If the dispute is unresolved, the Telephone Company may initiate an audit. The Telephone Company shall limit audits of the customer's PVU factor to no more than four times per year. The customer may request that the audit be conducted by an independent auditor. In such cases, the associated auditing expenses will be paid by the customer.
- (a) In the event that the customer fails to provide adequate records to enable the Telephone Company or an independent auditor to conduct an audit verifying the customer's PVU factors, the Telephone Company will bill the usage for all contested periods using the most recent undisputed PVU factors reported by the customer. These PVU factors will remain in effect until the audit can be completed.
- (b) During the audit, the undisputed PVU factors from the previous reporting period will be used by the Telephone Company.
- (c) The Telephone Company will adjust the customer's PVU factors based on the results of the audit and implement the revised PVU in the next billing period or quarterly report date, whichever is first. The revised PVU factors will apply for the next two quarters before new factors can be submitted by the customer.
- (d) If the audit supports the customer's PVU factors, the usage for the contested periods will be adjusted to reflect the customer's audited PVU factors. (N)

ACCESS SERVICE

2. General Regulations (Cont'd)**2.4 Payment Arrangements****2.4.1 Payment of Rates, Charges and Deposits****(A) Deposits**

The Telephone Company will, in order to safeguard its interests, only require a customer which has a proven history of late payments to the Telephone Company or does not have established credit, to make a deposit prior to or at any time after the provision of a service to the customer to be held by the Telephone Company as a guarantee of the payment of rates and charges. The Telephone Company will notify the customer of a deposit requirement by Overnight Delivery. The customer will be required to make payment of such deposit prior to the provision of service in those cases where the customer has not established credit with the Telephone Company, or otherwise within fifteen (15) business days of such notice. Such notice will start the day after the notice is sent by Overnight Delivery. No such deposit will be required of a customer which is a successor of a company which has established credit and has no history of late payments to the Telephone Company. Such deposit may not exceed the actual or estimated rates and charges for the service for a two month period. The fact that a deposit has been made in no way relieves the customer from complying with the Telephone Company's regulations as to the prompt payment of bills. At such time as the provision of the service to the customer is terminated, the amount of the deposit will be credited to the customer's account and any credit balance which may remain will be refunded.

Such a deposit will be refunded or credited to the account when the customer has established credit or, in any event, after the customer has established a one-year prompt payment record at any time prior to the termination of the provision of the service to the customer. In case of a cash deposit, for the period the deposit is held by the Telephone Company, the customer will receive simple annual interest at a rate of 1% per month or 12% annually. Should a deposit be credited to the customer's account, as indicated above, no interest will accrue on the deposit from the date such deposit is credited to the customer's account.

ACCESS SERVICE

- 2. General Regulations (Cont'd)
- 2.4 Payment Arrangements (Cont'd)
- 2.4.1 Payment of Rates, Charges and Deposits (Cont'd)
- (B) Payment of Rates and Charges

The Telephone Company shall bill on a current basis all charges incurred by and credits due to the customer under this tariff attributable to services established or discontinued during the preceding billing period. In addition, the Telephone Company shall bill in advance charges for all services to be provided during the ensuing billing period except for charges associated with service usage and for the Federal Government which will be billed in arrears. The bill day (i.e., the billing date of a bill for a customer for Access Service under this tariff), the period of service each bill covers and the payment date will be as follows:

- (1) For End User Access Service and Presubscription Service, the Telephone Company will establish a bill day each month for each end user account. The bill will cover End User Access Service charges for the ensuing billing period except for End User Access Service for the Federal Government which will be billed in arrears. Any applicable Presubscription Charges, any known unbilled charges for prior periods and any known unbilled adjustments for prior periods for End User Access Service and Presubscription Service will be applied to this bill. Such bills are due when rendered.
- (2) For Switched Access Service, Special Access Service, and Miscellaneous Service charges, the Telephone Company will establish a bill day each month for each customer account. The bill will cover nonusage sensitive service charges for the ensuing billing period for which the bill is rendered, any known unbilled nonusage sensitive charges for prior periods and unbilled usage charges for the period after the last bill day through the current bill day. Any known unbilled usage charges for prior periods and known unbilled adjustments will be applied to this bill. Payment for such bills is due as set forth in (3) following. If payment is not received by the payment date, as set forth in (3) following in immediately available funds, a late payment penalty will apply as set forth in (C) following.
- (3) All bills dated as set forth in (2) preceding for service, provided to the customer by the Telephone Company are due 31 days (payment date) after the bill date or by the next bill date (i.e., same date in the following month as the bill date), whichever is the shortest interval, except as

ACCESS SERVICE

- 2. General Regulations (Cont'd)
- 2.4 Payment Arrangements (Cont'd)
- 2.4.1 Payment of Rates, Charges and Deposits (Cont'd)
- (B) Payment of Rates and Charges (Cont'd)
 - (3) (Cont'd)

provided herein, and are payable in immediately available funds. If such payment date would cause payment to be due on a Saturday, Sunday or Holiday (i.e., New Year's Day, Independence Day, Labor Day, Thanksgiving Day, Christmas Day, the first Tuesday in November and the day when Washington's Birthday, Memorial Day or Columbus Day is legally observed), payment for such bills will be due from the customer as follows:

If such payment date falls on Sunday or on a Holiday which is observed on a Monday, the payment date shall be the first non-Holiday day following such Sunday or Holiday. If such payment date falls on a Saturday or on a Holiday which is observed on Tuesday, Wednesday, Thursday or Friday, the payment date shall be the last non-Holiday day preceding such Saturday or Holiday.

- (C) Late Payment Penalty

If the entire amount billed is not received by the Telephone Company in immediately available funds by the payment date, an additional charge (late payment charge) equal to 1/365th of the percentage rate for deposit interest as that in 2.4.1(A) of the unpaid balance will be applied for each day or portion thereof that an outstanding balance remains.

ACCESS SERVICE

2. General Regulations (Cont'd)**2.4 Payment Arrangements (Cont'd)****2.4.1 Payment of Rates, Charges and Deposits (Cont'd)****(D) Billing Disputes**

In the event that a billing dispute occurs concerning any charges billed to the customer by the Telephone Company the following regulations will apply.

- (1) A good faith dispute requires the customer to provide a written claim to the Telephone Company. Instructions for submitting a dispute can be obtained by calling the billing inquiry number shown on the customer's bill, or, by accessing the Telephone Company website also shown on the customer's bill. The written notice should contain the information specified in (2) following.
- (2) The date of the dispute shall be the date on which the customer furnishes the Telephone Company the following account information. Such written notice must identify in detail the basis for the dispute, and if the customer withholds disputed amounts, it must identify the account number under which the bill has been rendered, the date of the bill and the specific items on the bill being disputed, to permit the Telephone Company to investigate the merits of the dispute.
- (3) The date of resolution shall be the date on which the Telephone Company completes its investigation of the dispute, notifies the customer of the disposition and applies a credit for the amount of the dispute resolved in the customer's favor or late payment penalty as appropriate. The Telephone Company will work cooperatively with any customer to resolve billing disputes.
- (4) If a billing dispute is resolved in favor of the Telephone Company, any payments withheld pending resolution of the dispute shall be subject to the late payment penalty as set forth in (C) preceding.

ACCESS SERVICE

2. General Regulations (Cont'd)**2.4 Payment Arrangements (Cont'd)****2.4.1 Payment of Rates, Charges and Deposits (Cont'd)****(D) Billing Disputes (Cont'd)**

- (5) If the customer pays the bill in full by the payment due date, and later initiates a billing dispute within ninety days of the payment due date, penalty interest may be applicable.

If the billing dispute is resolved in favor of the customer, the customer shall receive a credit from the Telephone Company. This credit will be an amount equal to the disputed amount resolved in the customers' favor times a penalty factor of 1% per month or 12% annually. The penalty factor will apply from the date of the customer's payment through the date on which the credit is posted to the customer's account.

If the dispute is resolved in favor of the Telephone Company, neither a late payment charge nor a penalty interest charge is applicable.

- (6) If the customer pays the bill in full by the payment due date, and later initiates a billing dispute after ninety days of the payment due date, penalty interest may be applicable.

If the billing dispute is resolved in favor of the customer, the customer shall receive a credit from the Telephone Company. This credit will be an amount equal to the disputed amount resolved in the customers' favor times a penalty factor of 1% per month or 12% annually. The penalty factor will apply from the date of the dispute through the date on which the credit is posted to the customer's account.

If the dispute is resolved in favor of the Telephone Company, neither a late payment charge nor a penalty interest charge is applicable.

ACCESS SERVICE

- 2. General Regulations (Cont'd)
- 2.4 Payment Arrangements (Cont'd)
- 2.4.1 Payment of Rates, Charges and Deposits (Cont'd)
- (E) Billing Adjustments and Rounding

Adjustments for the quantities of services established or discontinued in any billing period beyond the minimum period set forth for services in other sections of this tariff will be prorated to the number of days or major fraction of days based on a 30 day month. When a rate as set forth in this tariff is shown to more than two decimal places, the charges will be determined using the rate shown. The resulting amount will then be rounded to the nearest penny (i.e., rounded to two decimal places).

ACCESS SERVICE

2. General Regulations (Cont'd)2.4 Payment Arrangements (Cont'd)2.4.1 Payment of Rates, Charges and Deposits (Cont'd)(F) Provision of Access Service Billing and Bill Verification

- (1) The Telephone Company will, upon reasonable request and if available, furnish such detailed information as may be required for verification of any bill.
- (2) The customer will receive its monthly bills in a standard paper format, or, at the customer's option, on magnetic tape in standard industry format for those access services for which the Telephone Company is technically capable of providing magnetic tape billing. The rules and regulations concerning payment arrangements and credit allowances described in this Section 2.4.1 apply to all primary monthly access bills, regardless of the chosen bill medium. Additional copies of the customer's bill may be provided in standard paper format at the rates and charges set forth in (3) following. When the customer requests a paper copy of the customer's bill in addition to the customer bill provided on magnetic tape, the rate set forth in (3) following shall apply per page.
- | | | |
|-----|--|---------------------------|
| (3) | Additional copies of the customer's
monthly bill or service and features
record in standard paper format, per page | <u>Rate</u>

\$0.00 |
|-----|--|---------------------------|

ACCESS SERVICE

2. General Regulations (Cont'd)**2.4 Payment Arrangements (Cont'd)****2.4.2 Minimum Periods**

The minimum period for which services are provided are for which rates and charges are applicable is one month except as otherwise specified. The minimum period for which DS3 services are provided and which rates are applicable are in Section 7. The minimum periods for which Expanded Interconnection Services are provided and which rates are applicable are in Section 17. The minimum periods for Optical Networking term plan services are provided and which rates and charges are applicable are in Section 20. The minimum period for which service is provided and for which rates and charges are applicable for a Specialized Service or Arrangement provided on an individual case basis as set forth in 12 following, is one month unless a different minimum period is established which the individual case filing. As specified in Section 5.3.3 following, when a service is discontinued prior to the expiration of the minimum period, charges are applicable, whether the service is used or not, as follows:

- (A) When a service with a one month minimum period is discontinued prior to the expiration of the minimum period, a one month charge will apply at the rate level in effect at the time service is discontinued.
- (B) When a service with a minimum period greater than one month is discontinued prior to the expiration of the minimum period, the applicable charge will be the lesser of:
 - (1) the Telephone Company's total nonrecoverable costs less the net salvage value for the discontinued service, or
 - (2) the total monthly charges, at the rate level in effect at the time service is discontinued, for the remainder of the minimum period.

2.4.3 Cancellation of an Order for Service

Provisions for the cancellation of an order for service are set forth in Section 5.3.2 following.

ACCESS SERVICE

- 2. General Regulations (Cont'd)
- 2.4 Payment Arrangements (Cont'd)
- 2.4.4 Reserved for Future Use

ACCESS SERVICE

2. General Regulations (Cont'd)**2.4 Payment Arrangements (Cont'd)****2.4.4 Reserved for Future Use (Cont'd)****2.4.5 Re-establishment of Service Following Fire, Flood or Other Occurrence****(A) Nonrecurring Charges Do Not Apply**

Charges do not apply for the re-establishment of service following a fire, flood or other occurrence attributed to an Act of God provided that:

- (1) The service is of the same type as was provided prior to the fire, flood or other occurrence.
- (2) The service is for the same customer.
- (3) The service is at the same location on the same premises.
- (4) The re-establishment of service begins within 60 days after Telephone Company service is available. (The 60 day period may be extended a reasonable period if the renovation of the original location on the premises affected is not practical within the allotted time period).

ACCESS SERVICE

2. General Regulations (Cont'd)**2.4 Payment Arrangements and Credit Allowances (Cont'd)****2.4.5 Re-establishment of Service Following Fire, Flood or Other Occurrence (Cont'd)****(B) Nonrecurring Charges Apply**

Nonrecurring Charges apply for establishing service at a different location on the same premises or at a different premises pending re-establishment of service at the original location.

2.4.6 Title or Ownership Rights

The payment of rates and charges by Customers for the services offered under the provisions of this tariff does not assign, confer or transfer title or ownership rights to proposals or facilities developed or utilized, respectively, by the Telephone Company in the provision of such services.

ACCESS SERVICE

2. General Regulations (Cont'd)**2.4 Payment Arrangements and Credit Allowances (Cont'd)****2.4.7 Access Services Provided by More Than One Telephone Company**

The Telephone Company will perform the rating and billing of Access Services under this tariff where more than one Telephone Company is involved in the provision of Access Service as set forth in (A) or (B) following. The Single Company Billing arrangement as set forth in (A) following will be used for FGA and BSA-A Switched Access Services except where interconnection arrangements between the telephone companies involved permit the use of the Multiple Company Billing arrangement as set forth in (B) following. The Telephone Company will notify the customer of the billing arrangement when the customer orders FGA or BSA-A service. The Multiple Company Billing arrangement, as set forth in (B) following, will be used for all FGB, FGC, FGD, BSA-B, BSA-C, BSA-D, 800/877/888 Access, and 900 Access Switched Access Services and Special Access Services.

(A) Single Company Billing

The Telephone Company receiving the order from the customer as specified in 5.2(A) following will arrange to provide the service, determine the applicable charges and bill the customer for the entire service in accordance with its Access Services tariff.

(B) Multiple Company Billing

- (1) For access services subject to Multiple Company Billing, the customer will be billed in accordance with the Exchange Carrier Standards Association's Multiple Exchange Carrier Access Billing Guidelines (MECAB) and Multiple Exchange Carrier Ordering and Design Guidelines (MECOD). One of the following methods will be used:

Single Bill - The customer will receive a single bill for all access services provided by multiple Telephone Companies. The single bill will include all rate elements applicable to the access service provided under one billing account.

ACCESS SERVICE

2. General Regulations (Cont'd)**2.4 Payment Arrangements and Credit Allowances (Cont'd)****2.4.7 Access Services Provided by More Than One Telephone Company (Cont'd)****(B) Multiple Company Billing (Cont'd)**

- (1) Multiple Bill -The customer will receive a bill from each Telephone Company providing the access service. Multiple bills will include all charges applicable to the individual portion of the access service provided by each Telephone Company. Such bills will include the following information in accordance with the MECAB Guidelines:

- Billing Account Reference (BAR)
- Billing Account Cross Reference (BACR)
- Billing Account Number (BAN)
- End Office NPA/NXX or End Office CLLI Code
- Common EC Circuit Identifiers (Special Access)
- Billing Percentages as listed in NECA Tariff No. 4
- Percent Interstate Usage (PIU)
- Usage "from" and "through" dates

The choice of billing method shall be determined by the Telephone Companies involved. The Telephone Company will notify the customer which method applies when the customer orders access service and will provide the customer thirty days' notice in the event that the billing method is changed.

- (2) When Terminating Tandem Switched Transport is provided through a Frontier Telephone ILEC access Tandem and the Terminating End Office is not owned by a Frontier Telephone ILEC Company or through an ILEC Access Tandem not owned by a Frontier Telephone ILEC Company and the Terminating End Office is owned by a Frontier Telephone ILEC Company, Terminating – Tandem 3rd Party rates are applicable, otherwise Terminating – Tandem End Office rates are applicable. When originating Tandem Switched Transport is provided, Originating rates are applicable. The Telephone Company will determine the applicable charges as follows: (N)

- (a) Determine the distance in airlines miles using the V&H method set forth in National Exchange Carrier Association Tariff FCC No. 4, between the Telephone Company's end office and the customer's serving wire center, or between the Telephone Company access tandem and the end office if Direct-Trunked Transport is ordered directly to the Telephone Company access tandem. (N)

ACCESS SERVICE

2. General Regulations (Cont'd)2.4 Payment Arrangements and Credit Allowances (Cont'd)2.4.7 Access Services Provided by More Than One Telephone Company (Cont'd)(B) Multiple Company Billing (Cont'd)

(2) (Cont'd)

(b) The airline distance in miles developed in (a) will be multiplied by the Tandem-Switched Transport Facility rate times the number of access minutes of use times the billing percentage to determine the appropriate Local Transport charges. The billing percentage is that portion of local transport to be billed by each company and is mutually agreed upon by the Telephone Companies involved in providing Access Services to the customer. Billing percentages are listed in National Exchange Carrier Association Tariff FCC No. 4.

(c) The total Local Transport charge shall be the Tandem-Switched Transport Facility charge as determined in (b) plus the Tandem-Switched Transport Termination rate times the number of access minutes of use times the number of terminations.

Where the Tandem-Switched Transport-Facility is provided by more than one telephone company, the Tandem-Switched Transport-Termination rate applies for the termination at the Telephone Company end of the Tandem-Switched Transport (i.e., the first point of switching or the end office serving the end user). The Switched Transport Termination rate will not apply when the Telephone Company is the intermediate provider of the Switched Transport Facility.

(d) All other appropriate recurring and nonrecurring charges in each Telephone Company's access tariff are applicable. The Nonrecurring Charges for Switched Access, as set forth in 6.5.4, apply in full.

(e) ExamplesExample 1: Originating Switched Access

(See Diagram 1)

- Feature Group D Switched Access is ordered to End Office.
- Originating End Office and Access Tandem are in the operating territory of a Telephone Company (TC-A).
- Customer Designated Premises is in the operating territory of a Telephone Company (TC-B)
- Assumptions:
 - TC-A Direct Trunk Transport BP = 40%
 - TC-B Direct Trunk Transport BP = 60%
 - Direct Trunked Transport mileage = 26 mi.
 - Tandem Switched Transport mileage = 23 mi.

(N)

(N)

ACCESS SERVICE

- 2. General Regulations (Cont'd) (N)
- 2.4 Payment Arrangements and Credit Allowances (Cont'd)
- 2.4.7 Access Services Provided by More Than One Telephone Company (Cont'd)
- (B) Multiple Company Billing (Cont'd)
- (2) (Cont'd)
- (e) Examples (Cont'd)

Example 1: Originating Switched Access
(See Diagram 1)

- Diagram 1

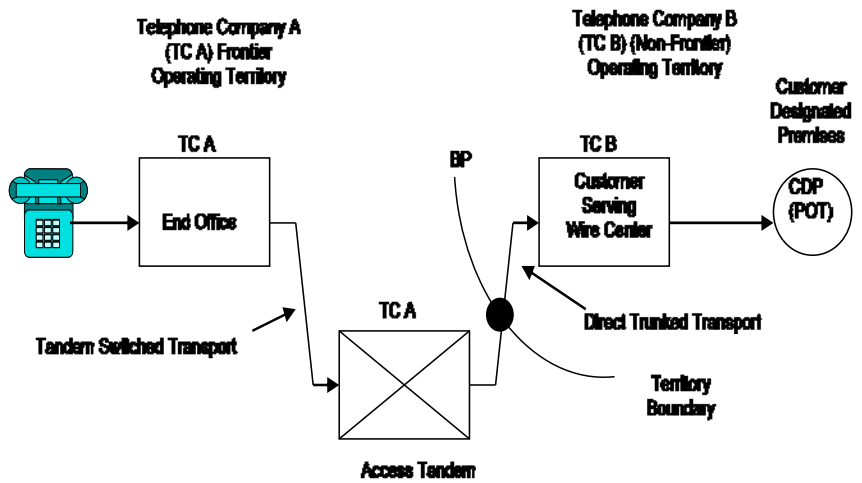

ACCESS SERVICE

2. General Regulations (Cont'd)2.4 Payment Arrangements and Credit Allowances (Cont'd)2.4.7 Access Services Provided by More Than One Telephone Company (Cont'd)(B) Multiple Company Billing (Cont'd)

(2) (Cont'd)

(e) Examples (Cont'd)

Example 1: Originating Switched Access (Cont'd)
(See Diagram 1)

- Telephone Company A charges are:
 - End Office charges = 9,000 min. x EO rate
 - Tandem Switched Transport Facility charge = 9,000 min. x 23 mi. x TSF rate
 - Tandem Switched Transport Termination charge = 2 terminations x 9,000 min. x TST rate
 - Tandem Switching Rate = 9,000 min. x TS rate
 - Direct Trunked Facility charge = 26 mi. x DTF rate x 40%
 - Direct Trunked Termination charge = 1 termination x DTT rate
 - Shared Multiplexing charge = 9,000 min. x SM rate

Example 2: Terminating Switched Access – Tandem 3rd Party
(See Diagram 2A and 2B)

- Feature Group D Switched Access is ordered to End Office.
- Terminating Access Tandem is owned by Frontier Telephone ILEC Companies (TC-A) and End Office is owned by a non-Frontier Telephone Company (TC –B).
- Assumptions:
 - *TC-A Direct Trunk Transport BP = 40%
 - *TC-B Direct Trunk Transport BP = 60%
 - Direct Trunk Transport mileage = 26 mi.
 - TC-A Tandem Switched Transport BP = 20%
 - TC-B Tandem Switched Transport BP = 80%
 - Tandem Switched Transport mileage = 23 mi.

(N)

(N)

*Where applicable see Diagram 2A

ACCESS SERVICE

2. General Regulations (Cont'd)

2.4 Payment Arrangements and Credit Allowances (Cont'd)

2.4.7 Access Services Provided by More Than One Telephone Company (Cont'd)

(B) Multiple Company Billing (Cont'd)

(2) (Cont'd)

(e) Examples (Cont'd)

Example 2: Terminating Switched Access – Tandem 3rd Party (Cont'd)
(See Diagram 2A and 2B)

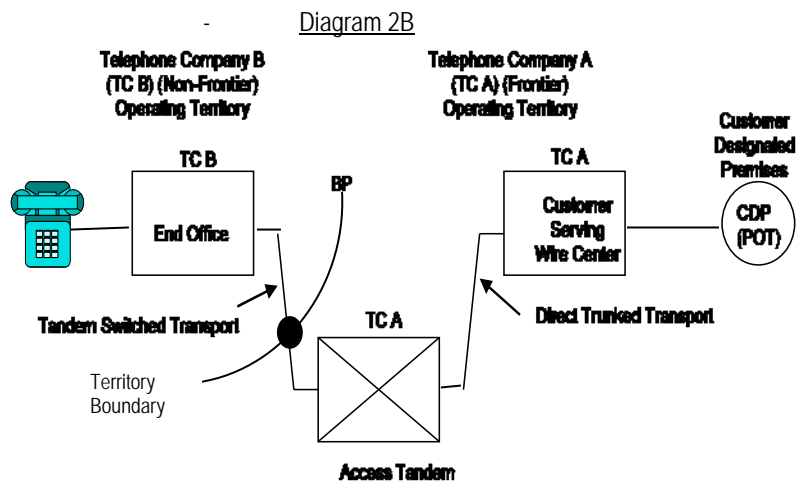
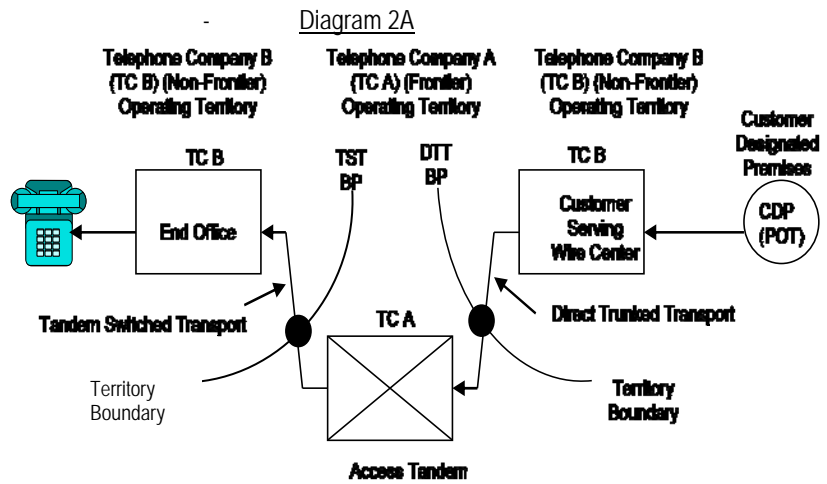

ACCESS SERVICE

2. General Regulations (Cont'd) (N)
- 2.4 Payment Arrangements and Credit Allowances (Cont'd)
- 2.4.7 Access Services Provided by More Than One Telephone Company (Cont'd)
- (B) Multiple Company Billing (Cont'd)
- (2) (Cont'd)
- (e) Examples (Cont'd)
- Example 2: Terminating Switched Access – Tandem 3rd Party (Cont'd)
(See Diagram 2A and 2B)
- Telephone Company A charges are:
 - Tandem Switched Transport Facility-3rd Party charge
= 9,000 min. x 23 mi. x TSF-3rd Party rate x 20%
 - Tandem Switched Transport Termination-3rd Party charge
= 1 termination x 9,000 min. x TST – 3rd Party rate
 - Tandem Switching-3rd Party Rate = 9,000 min. x TS-3rd Party rate
 - Direct Trunked Facility charge
2A = 26 miles. x DTF rate x 40%
2B = 26 miles. x DTF rate
 - Direct Trunked Termination charge
2A = 1 termination x DTT rate
2B = 2 termination x DTT rate
 - Shared Multiplexing 3rd Party Charge = 9,000 min. x SM-3rd Party rate (N)

ACCESS SERVICE

2. General Regulations (Cont'd)

2.4 Payment Arrangements and Credit Allowances (Cont'd)

2.4.7 Access Services Provided by More Than One Telephone Company (Cont'd)

(B) Multiple Company Billing (Cont'd)

(2) (Cont'd)

(e) Examples (Cont'd)

Example 3: Terminating Switched Access - Tandem End Office
(See Diagram 3)

- Feature Group D Switched Access is ordered to End Office.
- Terminating End Office and Access Tandem are both owned by Frontier Telephone ILEC Companies (TC-A).
- Assumptions:
 - TC-A Direct Trunk Transport BP = 40%
 - TC-B Direct Trunk Transport BP = 60%
 - Direct Trunk Transport mileage = 26 mi.
 - Tandem Switched Transport mileage = 23 mi.
- Diagram 3

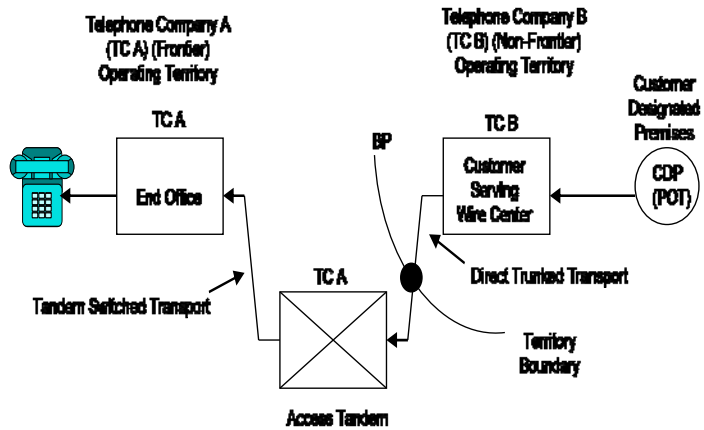

(N)

(N)

ACCESS SERVICE

2.	<u>General Regulations</u> (Cont'd)	(N)
2.4	<u>Payment Arrangements and Credit Allowances</u> (Cont'd)	
2.4.7	<u>Access Services Provided by More Than One Telephone Company</u> (Cont'd)	
(B)	<u>Multiple Company Billing</u> (Cont'd)	
(2)	(Cont'd)	
(e)	Examples (Cont'd)	
	<u>Example 3 –Terminating Switched Access Tandem End Office</u> (Cont'd) (See Diagram 3)	
	<ul style="list-style-type: none"> - Telephone Company A charges are: - End Office Charges = 9,000 min. x EO rate - Tandem Switched Facility – End Office charge = 9,000 min. x 23 mi. x TSF-End Office rate. - Tandem Switched Transport Termination –End Office charge = 2 terminations x 9.000 min. x TST-End Office rate. - Tandem Switching – End Office charge = 9,000 min. x TS-End Office rate - Direct Trunked Facility Charge = 26 miles x DTF rate x 40% - Direct Trunked Termination charge = 1 termination x DTT rate - Shared Multiplexing charge = 9,000 min. x SM-End Office rate 	(N)

ACCESS SERVICE

- 2. General Regulations (Cont'd) (N)
- 2.4 Payment Arrangements and Credit Allowances (Cont'd)
- 2.4.7 Access Services Provided by More Than One Telephone Company (Cont'd)
- (B) Multiple Company Billing (Cont'd)
- (2) (Cont'd)
- (e) Examples (Cont'd)

Example 4: Terminating Switched Access-Tandem 3rd Party
(See Diagram 4)

- Feature Group D Switched Access is ordered to End Office.
- End Office is owned by Frontier Telephone Company (TC-A).
- Access Tandem is owned by a non-Frontier Telephone ILEC Company (TC-B).
- Diagram 4

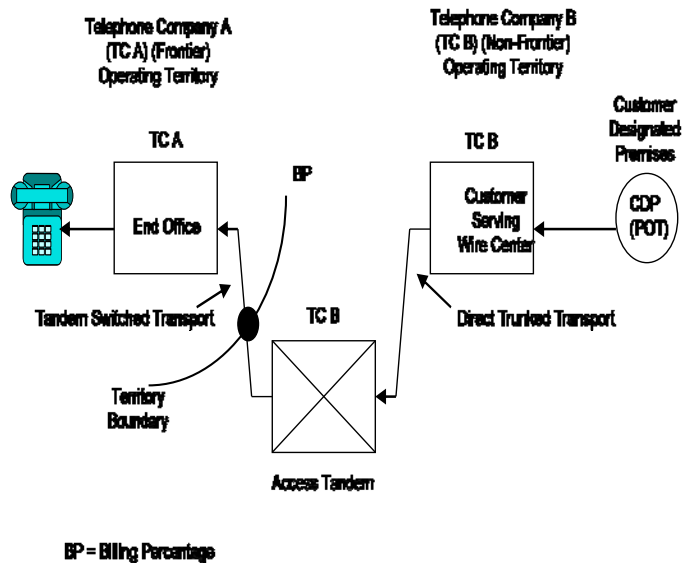

ACCESS SERVICE

2.	<u>General Regulations</u> (Cont'd)	(N)
2.4	<u>Payment Arrangements and Credit Allowances</u> (Cont'd)	
2.4.7	<u>Access Services Provided by More Than One Telephone Company</u> (Cont'd)	
(B)	<u>Multiple Company Billing</u> (Cont'd)	
(2)	(Cont'd)	
(e)	Examples (Cont'd)	
	<u>Example 4: Terminating Switched Access-Tandem 3rd Party</u> (Cont'd) (See Diagram 4)	
	- Telephone Company A charges are:	
	- End Office charges = 9,000 min x EO rate	
	- Tandem Switched Facility -3 rd Party charge = 9,000 min. x 23 mi. x TSF-3 rd Party rate x 80%	
	- Tandem Switched Termination -3 rd party charge = 1 termination x 9,000 min. x TST-3 rd Party rate	(N)

ACCESS SERVICE

2. General Regulations (Cont'd)

2.4 Payment Arrangements and Credit Allowances (Cont'd)

2.4.7 Access Services Provided by More Than One Telephone Company (Cont'd)

(B) Multiple Company Billing (Cont'd)

(2) (Cont'd)

(e) Examples (Cont'd)

Example 5: Originating Switched Access - Frontier Telephone ILEC Company owns only the End Office.
(See Diagram 5)

- Feature Group D Switched Access is ordered to End Office.
- End Office is owned by Frontier Telephone Companies (TC-A).
- Access Tandem is owned by a non-Frontier Telephone ILEC Company (TC-B)
- Assumptions:
 - Direct Trunk Transport mileage = 26 mi.
 - TC-A Tandem Switched Transport BP = 80%
 - TC-B Tandem Switched Transport BP = 20%
 - Tandem Switched Transport mileage = 23 mi.
- Diagram 5

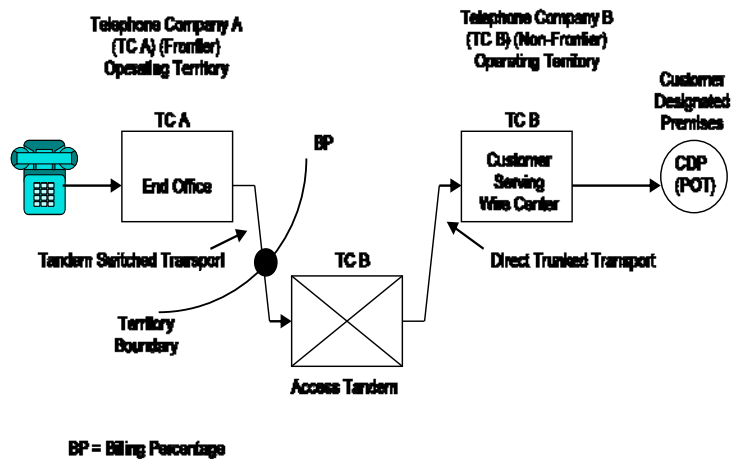

(N)

(N)

ACCESS SERVICE

2. General Regulations (Cont'd) (N)
- 2.4 Payment Arrangements and Credit Allowances (Cont'd)
- 2.4.7 Access Services Provided by More Than One Telephone Company (Cont'd)
- (B) Multiple Company Billing (Cont'd)
- (2) (Cont'd)
- (e) Examples (Cont'd)
- Example 5: Originating Switched Access - Frontier Telephone ILEC Company owns only the End Office. (Cont'd)
(See Diagram 5)
- Telephone Company A charges are:
 - End Office charges = 9,000 min. x EO rate
 - Tandem Switched Transport Facility charge
= 9,000 min. x 23 mi. x TSF rate x 80%.
 - Tandem Switched Transport Termination charge
= 1 termination x 9.000 min. x TST rate.
- (3) For Special Access Services and Switched Access Direct-Trunked Transport, the Telephone Company will determine the applicable charges as follows: (M)
- (a) Determine the distance in airline miles using the V&H method set forth in National Exchange Carrier Association Tariff No. 4 between the locations involved; i.e., the serving wire center associated with a customer designated premise and an end office, or a Telephone Company hub, or two Telephone Company hubs, a hub to an end office, or a hub to a Telephone Company access tandem. (M)

(M) This material was previously on Original Page 2-27

ACCESS SERVICE

2. General Regulations (Cont'd)
- 2.4 Payment Arrangements and Credit Allowances (Cont'd)
- 2.4.7 Access Services Provided by More Than One Telephone Company (Cont'd)
- (B) Multiple Company Billing (Cont'd)
- (3) (Cont'd)
- (b) The airline distance in miles developed in (a) preceding will be multiplied by the Special Access Circuit Mileage-Per Mile or Switched Access Direct-Trunked Transport Mileage rate element times the billing percentage to determine the appropriate charges. The billing percentage is that portion of circuit mileage to be billed by each company involved in providing Access Services to the customer. Billing percentages are listed in National Exchange Carrier Association Tariff FCC No. 4.
- (c) For Special Access, the total Circuit Mileage charges shall be the Circuit Mileage-Per Mile charge determined in (b) preceding plus the Circuit Mileage-Fixed charges. The Circuit Mileage-Fixed charge is always applied in full, once per circuit mileage facility, whether the Telephone Company provides one, or more than one, circuit mileage facility termination(s). The Circuit Mileage-Fixed rate does not apply when the Telephone Company provides an intermediate portion of a circuit mileage facility and no circuit mileage terminations.
- (d) For Switched Access, the total Direct-Trunked Transport charges shall be the Direct-Trunked Transport Mileage charge determined in (b) preceding plus the Direct-Trunked Transport - Fixed charges. The Fixed charge is always applied in full, once per Direct-Trunked Transport facility whether the Telephone Company provides one, or more than one, facility termination(s). The Fixed charge does not apply when the Telephone Company provides an intermediate portion of a Direct-Trunked Transport facility and no terminations.
- (e) All other appropriate recurring and nonrecurring charges in each Telephone Company's access tariff are applicable. The Special Access Nonrecurring Charge for circuit installation applies in full once per Circuit Termination provided by the Telephone Company.
- (4) The Interconnection Charge for Switched Transport shall be billed by the Telephone Company in whose territory the end office is located.

ACCESS SERVICE

2. General Regulations (Cont'd)

2.4 Payment Arrangements and Credit Allowances (Cont'd)

2.4.7 Access Services Provided by More Than One Telephone Company (Cont'd)

(B) Multiple Company Billing (Cont'd)

- (5) The shared trunk port for Tandem-Switched Transport shall be billed by the Telephone Company in whose territory the end office is located.
- (6) For tandem routed trunks, the dedicated trunk port shall be billed by the Telephone Company owning the tandem. For end office direct routed trunks, the dedicated trunk port shall be billed by the Telephone Company owning the end office on a single bill, single tariff or multiple bill, multiple tariff meet point billing arrangement.
- (7) The shared multiplexing charge will be assessed to the interexchange carrier by the Telephone Company owning the access tandem under the multiple bill, multiple tariff meet point billing option, and to the initial billing company, by the Telephone Company owning the access tandem, under the single bill, single tariff meet point billing option.
- (8) For Dedicated SONET Optical Transport Service (DSOTS), as set forth in Section 20.1 following, and Dedicated SONET Ring (DSR), as set forth in Section 20.2 following, where the ring is provided within the operating territories of two or more telephone companies, ring mileage is determined using the methodology below. The following illustrates the methodology used to determine DSOTS ring mileage.

Step 1 – Calculate the total ring mileage by summing the mileage connecting all locations and devices (Node A to SWC CDL B) + (SWC CDL B to Node CDL B) + (Node CDL B to CO Node C) + (CO Node C to Node CDL D) + (Node CDL D to SWC CDL D) + (SWC Node D to Node A), If the total ring mileage includes a fraction of a mile, the value is rounded up to the next full mile.

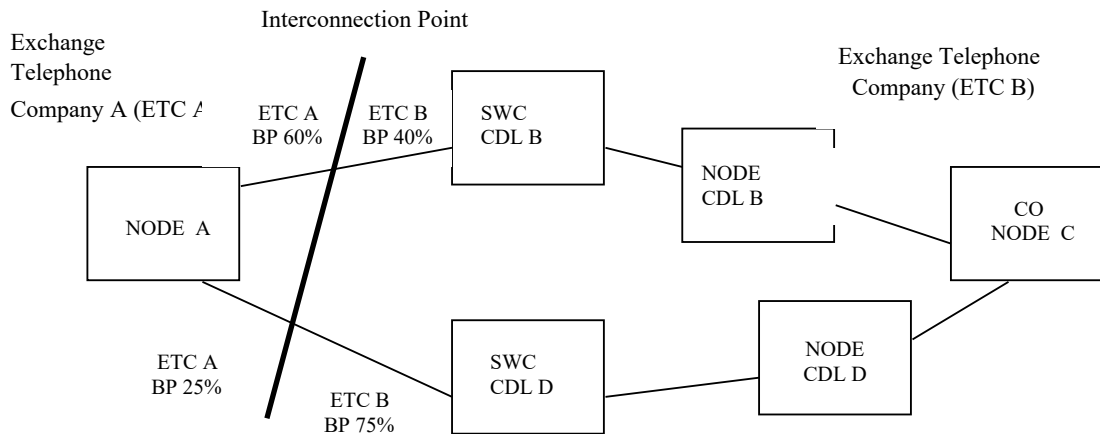

ACCESS SERVICE

- 2. General Regulations (Cont'd)
- 2.4 Payment Arrangements and Credit Allowances (Cont'd)
- 2.4.7 Access Services Provided by More Than One Telephone Company (Cont'd)
- (B) Multiple Company Billing (Cont'd)

(8) (Cont'd)

Step 2 – Determine the Telephone Company (ETCB) portion of the total ring mileage by first multiplying the mileage between Node A and the SWC of CDL B by the billing percentage (BP) for ETC B (40%) and between the SWC CDL D and Node A by the BP for ETCB (75%) and adding these adjusted mileage segments to the remaining mileage segments on the ring (SWC CDL B to Node CDL B) + (Node CDL B to CO Node C) + (CO Node C to Node CDL D) + (Node CDL D to SWC CDL D). If this ring mileage calculation includes a fraction of a mile, the value is rounded up to the next full mile. If the Telephone Company (ETCB) portion of the total ring mileage is 20 miles or less, utilize the process set forth in Step 3 following to determine the mileage charges for each exchange telephone company involved. If the Telephone Company (ETCB) portion of the total ring mileage is 21 miles or over, utilize the process set forth in Step 4 through Step 6 following to determine the mileage charges for each exchange telephone company involved.

Step 3 – Develop a Ring BP by dividing the Telephone Company (ETCB) portion of the total ring miles determined in Step 2 by the total ring miles determined in Step 1. Next apply this Ring BP to the total ring mileage for ETCB determined in Step 2 and apply the rates set forth in 20.1(K) for 1-20 total ring miles.

Step 4 - If the Telephone Company (ETCB) portion of the total ring miles determined in Step 2 is 21 miles or more, apply the 1-20 ring mileage rate set forth in 20.1(K) following to the first 20 miles.

Step 5 - Determine the remaining Telephone Company (ETCB) portion of the total ring mileage by subtracting 20 miles from the Telephone Company (ETCB) portion of the total ring mileage determined in Step 2. Next apply the rates set forth in 20.1(K) for mile 21 and over up to the Telephone Company (ETCB) portion of the total ring miles.

Step 6 –The total charge for ring mileage is the sum of the charges for the first 20 miles calculated in Step 4 plus the remaining miles billed at the rate for 21 miles and over as calculated in this Step 5.

ACCESS SERVICE

2. General Regulations (Cont'd)**2.5 Connections****2.5.1 General**

Equipment and Systems (i.e., terminal equipment, multiline terminating systems and communications systems) may be connected with Switched and Special Access Service furnished by the Telephone Company where such connection or interconnection is made in accordance with the provisions specified in Technical Reference PUB AS No. 1, Issue II, and in Section 2.1 preceding.

2.5.2 Standard Access Service Connections

Access services are provided by means of wire, fiber optics, radio or any other suitable technology or a combination thereof. Special Access service connections are made directly or through a Telephone Company hub where bridging or multiplexing functions are performed. These connections can either be analog or digital.

2.5.3 Expanded Interconnection Service (EIS) - Fiber Optic

Fiber Optic EIS provides a customer with space and associated requirements such as power and environmental conditioning within or near a Telephone Company wire center or Telephone Company access tandem to locate certain fiber optic facilities and equipment, and an interconnection with certain Telephone Company provided facilities.

EIS will be provided subject to the regulations and rates and charges set forth in Section 17.

2.5.4 Expanded Interconnection Service (EIS) - Microwave

Microwave EIS provides a customer with space and associated requirements such as power and environmental conditioning within a Telephone Company wire center or Telephone Company access tandem to locate certain microwave facilities and equipment, and a connection to certain Telephone Company provided facilities.

Customer-provided microwave facilities, equipment and support structures may be located in, on or above the exterior walls and roof of Telephone Company wire center or Telephone Company access tandem. Such interconnection must be made in accordance with the provisions specified in 2.1. These interconnections will be provided subject to the regulations and rates and charges set forth in Section 17.

ACCESS SERVICE

2. General Regulations (Cont'd)**2.6 Definitions**

Certain terms used herein are defined as follows:

Access Area

The term "Access Area" denotes a specific calling area serviced by one or more Central Offices associated with the various Switched Access Services offered under this tariff. The size and configuration of the Access Area a customer obtains is dependant upon the Feature Group type and the specific characteristics of the Central Office or Telephone Company Access Tandem Network in which the connection is made.

Access Code

The term "Access Code" applies to Switched Access Service. It denotes a uniform seven digit code dialed by an end user to access an Interexchange Carrier's facilities. The five or seven digit FGD code has the form 101XXXX, and the seven digit FGB code has the form 950-XXXX.

Access Minutes

The term "Access Minutes" denotes that usage of exchange facilities in interstate or foreign service for the purpose of calculating chargeable usage. On the originating end of an interstate or foreign call, usage is measured from the time the originating end user's call is delivered by the Telephone Company to and acknowledged as received by the customer's facilities connected with the originating exchange. On the terminating end of an interstate or foreign call, usage is measured from the time the call is received by the end user in the terminating exchange. Timing of usage at both originating and terminating ends of an interstate or foreign call shall terminate when the calling or called party disconnects, whichever event is recognized first in the originating and terminating exchanges, as applicable.

Access Tandem

The term "Access Tandem" denotes a Telephone Company switching system that provides a concentration and distribution function for originating and/or terminating traffic between end offices and a customer's premises.

ACCESS SERVICE

2. General Regulations (Cont'd)**2.6 Definitions (Cont'd)****Access Tandem Network**

The term "Access Tandem Network" denotes the network of trunk groups that provide a concentration and distribution function for originating and/or terminating Switched Access traffic between a single Telephone Company access tandem and Telephone Company subtending end offices.

Add/Drop Multiplexing

The term "Add/Drop Multiplexing" denotes a multiplexing function that allows lower level signals to be added or dropped with the remaining traffic continuing through the network.

Agent

The term "Agent," as used in Section 8.5 of this tariff, is defined as that person or entity that the Telephone Company acknowledges as the possessor of authority to make decisions pertaining to instrument placement, subscription authorization, and access or usage control of Pay Telephone Service or, that person or entity duly authorized to act in that capacity by the owner of the premises.

Aggregator

The term "Aggregator" denotes any individual, partnership, association, joint-stock company, trust or corporation that, in the ordinary course of its operations, makes telephones available to the public or to transient users of its premises, for interstate telephone calls using a provider of operator services.

Answer Message

The term "Answer Message" denotes an SS7 message sent in the backward direction to indicate that the call has been answered.

ACCESS SERVICE

2. General Regulations (Cont'd)**2.6 Definitions (Cont'd)**Answer/Disconnect Supervision

The term "Answer/Disconnect Supervision" denotes the transmission of the switch trunk equipment supervisory signal (off-hook or on-hook) to the customer's point of termination as an indication that the called party has answered or disconnected.

Attenuation Distortion

The term "Attenuation Distortion" denotes the difference in loss at specified frequencies relative to the loss at 1004 Hz, unless otherwise specified.

Balance (100 Type) Test Line

The term "Balance (100 Type) Test Line" denotes an arrangement in an end office which provides for balance and noise testing.

Basic Service Element

The term "Basic Service Element (BSE)" denotes an unbundled service option available only with Basic Serving Arrangements.

Basic Serving Arrangement

The term "Basic Serving Arrangement (BSA)" denotes a category of Switched Access Service differentiated by technical characteristics, e.g., line side versus trunk side connection at the Telephone Company's first point of switching.

ACCESS SERVICE

2. General Regulations (Cont'd)**2.6 Definitions (Cont'd)****Bit**

The term "Bit" denotes the smallest unit of information in the binary system of notation.

Business Day

The term "Business Day" denotes the times of day that a company is open for business. Generally, in the business community, these are 8:00 or 9:00 A.M. to 5:00 or 6:00 P.M., respectively, with an hour for lunch, Monday through Friday, resulting in a standard forty (40) hour work week. However, Business Day hours for the Telephone Company may vary based on company policy, union contract and location. To determine such hours for an individual company, or company location, contact the issuing officer at the address shown on Title Page 1.

Busy Hour Minutes of Capacity (BHMC)

The term "Busy Hour Minutes of Capacity (BHMC)" denotes the customer specified maximum amount of Switched Access Service access minutes the customer expects to be handled in an end office switch during any hour in an 8:00 A.M. to 11:00 P.M. period for the Switched Access Arrangement ordered. This customer furnished BHMC quantity is the input data the Telephone Company uses to determine the number of transmission paths or facility requirements for the Switched Access Arrangement ordered.

ACCESS SERVICE

2. General Regulations (Cont'd)**2.6 Definitions (Cont'd)**Call

The term "Call" denotes a customer attempt for which the complete address code (e.g., 0-, 911, or 10 digits) is provided to the serving dial tone office.

Carrier or Common Carrier

See Interexchange Carrier.

Carrier Identification Code

The term "Carrier Identification Code (CIC)" denotes the uniform access code associated with a specific Interexchange Carrier.

Carrier Identification Parameter

The term "Carrier Identification Parameter (CIP)" denotes a field in the SS7 Initial Address Message (IAM) that identifies and transmits the CIC information in a forward direction to an IC customer.

CCS

The term "CCS" denotes a hundred call seconds, which is a standard unit of traffic load that is equal to 100 seconds of usage or capacity of a group of servers (e.g., trunks).

Cellular Mobile Carrier (CMC)

The term "Cellular Mobile Carrier (CMC)" denotes a Common Carrier authorized by the Federal Communications Commission to provide cellular mobile radio telecommunications services.

ACCESS SERVICE

2. General Regulations (Cont'd)**2.6 Definitions (Cont'd)**Central Office

The term "Central Office" denotes a local Telephone Company switching system where Telephone Exchange Service customer station loops are terminated for purposes of interconnection to each other and to trunks.

Central Office Prefix

The term "Central Office Prefix" denotes the first three digits (NXX) of the seven digit telephone number assigned to a customer's Telephone Exchange Service when dialed on a local basis.

Centralized Automatic Reporting on Trunks Testing

The term "Centralized Automatic Reporting on Trunks Testing" denotes a type of testing which includes the capacity for measuring operational and transmission parameters.

ACCESS SERVICE

2. General Regulations (Cont'd)**2.6 Definitions (Cont'd)**Channel Service Unit

The term "Channel Service Unit" denotes customer premises equipment which performs one or more of the following functions: termination of a digital facility, regeneration of digital signals, detection and/or correction of signal format error, and remote loop back.

Channelize

The term "Channelize" denotes the process of multiplexing-demultiplexing wider bandwidth or higher speed channels into narrow band-width or lower speed channels.

Circuit(s)

The term "Circuit(s)" denotes an electrical or photonic, in the case of fiber optic-based transmission systems, communications path between two or more points of termination.

Circuit Code

The term "Circuit Code" denotes the service class routing of an SS7 call that indicates the interexchange carrier trunk group to which the traffic will be routed (e.g., 0+, 0-, 500, 900, etc.)

C-Message Noise

The term "C-Message Noise" denotes the frequency weighted average noise within an idle voice channel. The frequency weighing, called C-message, is used to simulate the frequency characteristic of the 500-type telephone set and the hearing of the average subscriber.

C-Notched Noise

The term "C-Notched Noise" denotes the C-message frequency weighted noise on a voice channel with a holding tone, which is removed at the measuring end through a notch (very narrow band) filter.

ACCESS SERVICE

2. General Regulations (Cont'd)**2.6 Definitions (Cont'd)****Coin Station**

The term "Coin Station" denotes a location where Telephone Company equipment is provided in a public or semipublic place where Telephone Company customers can originate telephone communications and pay the applicable charges by inserting coins into the equipment.

Concatenated

The term "Concatenated" denotes the linking together of various data structures, e.g., two bandwidths joined to form a single bandwidth.

Common Channel Signaling System 7 Network (CCS7)

The term "Common Channel Signaling System 7 Network (CCS7)" denotes a dedicated out-of-band signaling network which utilizes Signaling System 7 (SS7) protocol to provide call handling and data base access services.

ACCESS SERVICE

2. General Regulations (Cont'd)**2.6 Definitions (Cont'd)**Common Line

The term "Common Line" denotes a line, trunk, pay telephone line or other facility provided under the general and/or local exchange service tariffs of the Telephone Company, terminated on a central office switch. A common line-residence is a line or trunk provided under the residence regulations of the general and/or local exchange service tariffs. A common line-business is a line provided under the business regulations of the general and/or local exchange service tariffs.

Communications System

The term "Communications System" denotes channels and other facilities which are capable of communications between terminal equipment provided by other than the Telephone Company.

Competitive County

The term "Competitive County" denotes that the geographic unit of a county or county-equivalent that passes or has passed a competitive market test specified by the FCC. Competitive County also denotes a county or county-equivalent that failed a competitive market test specified by the FCC, but was granted Phase II, Level 2 pricing flexibility prior to June 1, 2017.

(N)
|
(N)Customer(s)

The term "Customer(s)" denotes any individual, partnership, association, joint-stock company, trust corporation, or governmental entity or other entity which subscribes to the services offered under this tariff.

Data Transmission (107 Type) Test Line

The term "Data Transmissions (107 Type) Test Line" denotes an arrangement which provides for a connection to a signal source which provides test signals for one-way testing of data and voice transmission parameters.

Decibel

The term "Decibel" denotes a unit used to express relative differences in power, usually between acoustic or electric signals, equal to ten (10) times the common logarithm of the ratio of two signal powers.

Decibel Reference Noise C-Message Weighting

The term "Decibel Reference Noise C-Message Weighting" denotes noise power measurements with C-Message Weighting in decibels relative to a reference 1000 Hz tone of 90 dB below 1 milliwatt.

ACCESS SERVICE

2. General Regulations (Cont'd)**2.6 Definitions (Cont'd)****Decibel Reference Noise C-Message Referenced to 0**

The term "Decibel Reference Noise C-Message Referenced to 0" denotes noise power in "Decibel Reference Noise C-Message Weighing" referred to or measured at a zero transmission level point.

Dual Tone Multifrequency Address Signaling

The term "Dual Tone Multifrequency Address Signaling" denotes a type of signaling that is an optional feature of Switched Access Feature Group A and BSA-A. It may be utilized when Feature Group A or BSA-A is being used in the terminating direction (from the point of termination with the customer to the local exchange and office). An office arranged for Dual Tone Multifrequency Signaling would expect to receive address signals from the customer in the form of Dual Tone Multifrequency signals.

Echo Control

The term "Echo Control" denotes the control of reflected signals in a telephone transmission path.

Echo Path Loss

The term "Echo Path Loss" denotes the measure of reflected signal at a 4-wire point of interface without regard to the send and receive Transmission Level Point.

Echo Return Loss

The term "Echo Return Loss" denotes a frequency weighted measure of return loss over the middle of the voiceband (approximately 500 to 2500 Hz), where talker echo is most annoying.

Effective 2-Wire

The term "Effective 2-Wire" denotes a condition which permits the simultaneous transmission in both directions over a channel, but it is not possible to insure independent information transmission in both directions. Effective 2-wire channels may be terminated with 2-wire or 4-wire interfaces.

ACCESS SERVICE

2. General Regulations (Cont'd)**2.6 Definitions (Cont'd)****Effective 4-Wire**

The term "Effective 4-Wire" denotes a condition which permits the simultaneous independent transmission of information in both directions over a channel. The method of implementing effective 4-wire transmission is at the discretion of the Telephone Company (physical, time domain, frequency-domain separation or echo cancellation techniques). Effective 4-wire channels may be terminated with a 2-wire interface at the customer's premises. However, when terminated 2-wire, simultaneous independent transmission cannot be supported because the two wire interface combines the transmission paths into a single path.

End Office Switch

The term "End Office Switch" denotes a local Telephone Company switching system where Telephone Exchange Service customer station loops are terminated for purposes of interconnection to each other and to trunks. Included may be Remote Switching Modules and Remote Switching Systems served by a host office in a different wire center.

End User

The term "End User" denotes any customer of interstate or foreign telecommunications service that is not a carrier, except that a carrier shall be deemed to be an "end user" to the extent that such carrier uses a telecommunications service for administrative purposes, without making such service available to others, directly or indirectly.

ACCESS SERVICE

2. General Regulations (Cont'd)**2.6 Definitions (Cont'd)**Entry Switch

See First Point of Switching.

Envelope Delay Distortion

The term "Envelope Delay Distortion" denotes a measure of the linearity of the phase versus frequency of a channel.

Equal Level Echo Path Loss

The term "Equal Level Echo Path Loss" (ELEPL) denotes the measure of Echo Path Loss (EPL) at a 4-wire interface which is corrected by the difference between the send and receive Transmission Level Point (TLP). [ELEPL = TLP (send) + TLP (receive)]

Exchange

The term "Exchange" denotes a unit generally smaller than a local access and transport area, established by the Telephone Company for the administration of communications service in a specified area which usually embraces a city, town or village and its environs. It consists of one or more central offices together with the associated facilities used in furnishing communications service within the area. One or more designated exchanges comprise a given local access and transport area.

Existing Suitable Space

The term "Existing Suitable Space" denotes a space in which ac/dc power, heat and air conditioning, battery and generator back-up power, and other requirements necessary for provision of wire center or access tandem equipment currently exists.

ACCESS SERVICE

2. General Regulations (Cont'd)**2.6 Definitions (Cont'd)**Exit Message

The term "Exit Message" denotes an SS7 message sent to an end office by the Telephone Company tandem switch to mark the Connect Time when the Telephone Company's tandem switch sends an Initial Address Message to a customer.

Expected Measured Loss

The term "Expected Measured Loss" denotes a calculated loss which specifies the end-to-end 1004-Hz loss on a terminated test connection between two readily accessible manual or remote test points. It is the sum of the inserted connection loss and test access loss including any test pads.

Extended Area Service

The term "Extended Area Service" denotes a telephone exchange service in which a customer in one exchange can call a local number in another exchange that is part of the extended area without paying a toll charge.

Extensible Markup Language (XML)

The term "Extensible Markup Language (XML)" denotes a simple, very flexible text format that is used in the exchange of a wide variety of data on the Web and elsewhere.

Facility

The term "Facility" denotes generically the various transmission media used for the transmission of telecommunications service. This included, but is not limited to, cable (copper pair, coaxial and fiber optic) and microwave radio equipment.

Field Identifier

The term "Field Identifier" denotes two to four characters that are used on service orders to convey specific instructions. Field Identifiers may or may not have associated data. Selected Field Identifiers are used in Telephone Company billing systems to generate nonrecurring charges.

First Come - First Served

The term "First Come - First Served" denotes a procedure followed by the Telephone Company to process fully completed Access Orders according to the sequence in which they are received.

ACCESS SERVICE

2. General Regulations (Cont'd)**2.6 Definitions (Cont'd)****First Point of Switching**

The term "First Point of Switching" denotes the first Telephone Company location at which switching occurs on the terminating path of a call proceeding from the customer premises to the terminating end office and, at the same time, the last Telephone Company location at which switching occurs on the originating path of a call proceeding from the originating end office to the customer premises.

Flexible Automatic Number Identification (FLEX ANI)

The term "Flexible Automatic Number Identification" denotes an optional feature or Basic Service Element that provides additional values for the information indicator digits available with the ANI feature on originating calls. These additional digits identify the type of line that is originating the call for billing, screening and routing purposes.

ACCESS SERVICE

2. General Regulations (Cont'd)**2.6 Definitions (Cont'd)****Frame**

The term "Frame" denotes a group of data bits, in specific format, with a flag at either end to indicate the beginning and end of the frame. The defined format enables network equipment to recognize the meaning and purpose of specific bits.

Frequency Shift

The term "Frequency Shift" denotes the change in the frequency of a tone as it is transmitted over a channel.

ACCESS SERVICE

2. General Regulations (Cont'd)**2.6 Definitions (Cont'd)****Grandfathered**

The term "Grandfathered" denotes Terminal Equipment, Multiline Terminating Systems and Protective Circuitry directly connected to the facilities utilized to provide services under the provisions of this tariff, and which are considered grandfathered under Part 68 of the F.C.C.'s Rules and Regulations.

Host Office

The term "Host Office" denotes an electronic switching system which provides call processing capabilities for one or more Remote Switching Modules or Remote Switching Systems.

Immediately Available Funds

The term "Immediately Available Funds" denotes a corporate or personal check drawn on a bank account and funds which are available for use by the receiving party on the same day on which they are received and include U.S. Federal Reserve bank wire transfers, U.S. Federal Reserve notes (paper cash), U.S. coins, U.S. Postal Money Orders and New York Certificates of Deposit.

Impedance Balance

The term "Impedance Balance" denotes the method of expressing Echo Return Loss and Singing Return Loss at a 4-wire interface whereby the gains and/or loss of the 4 wire portion of the transmission path, including the hybrid, are not included in the specification.

Impulse Noise

The term "Impulse Noise" denotes any momentary occurrence of the noise on a channel over a specified level threshold. It is evaluated by counting the number of occurrences which exceed the threshold.

Individual Case Basis

The term "Individual Case Basis" denotes a condition in which the regulations, if applicable, rates and charges for an offering under the provisions of this tariff are developed based on the circumstances in each case.

ACCESS SERVICE

2. General Regulations (Cont'd)**2.6 Definitions (Cont'd)****Initial Address Message (IAM)**

The term "Initial Address Message (IAM)" denotes an SS7 message sent in the forward direction to initiate trunk set up with the busy of an outgoing trunk which carries the information about that trunk along with other information relating to the routing and handling of the call to the next switch.

Inserted Connection Loss

The term "Inserted Connection Loss" denotes the 1004 H2 power difference (in dB) between the maximum power available at the originating end and the actual power reaching the terminating end through the inserted connection.

Interconnection

The term "Interconnection" denotes the termination of a customer's basic transmission facilities, including optical terminating equipment and multiplexers at or near Telephone Company wire center or Telephone Company access tandem. Interconnection may be provided as either physical or virtual.

Interconnection Point

The term "Interconnection Point" denotes physical EIS arrangements as the point where the customer-owned cable facilities connect to the Telephone Company termination equipment. The interconnection point for virtual EIS arrangements is the demarcation between ownership of the cable facilities.

ACCESS SERVICE

2. General Regulations (Cont'd)**2.6 Definitions (Cont'd)****Interexchange Carrier (IC) or Interexchange Common Carrier**

The terms "Interexchange Carrier" (IC) or "Interexchange Common Carrier" denotes any individual, partnership, association, joint-stock company, trust, governmental entity or corporation engaged for hire in interstate or foreign communications by wire or radio, between two or more exchanges.

Intermodulation Distortion

The term "Intermodulation Distortion" denotes a measure of the nonlinearity of a channel. It is measured using four tones, and evaluating the ratios (in dB) of the transmitted composite four-tone signal power to the second-order products of the tones (R2), and the third-order products of the tones (R3).

Interstate Communications

The term "Interstate Communications" denotes both interstate and foreign communications.

Intrastate Communications

The term "Intrastate Communications" denotes any communications within a state subject to oversight by a state regulatory commission as provided by the laws of the state involved.

Line Side Connection

The term "Line Side Connection" denotes a connection of a transmission path to the line side of a local exchange switching system.

ACCESS SERVICE

2. General Regulations (Cont'd)**2.6 Definitions (Cont'd)****Local Access and Transport Area**

The term "Local Access and Transport Area" (LATA) denotes a geographic area established by the Telephone Company for the provision and administration of its communications service. It encompasses one or more Telephone Company designated exchanges which are configured in relative proximity to one another and may be reconfigured by the Telephone Company in the normal operation of its business. As used herein, the term LATA refers only to these Telephone Company designated exchanges and does not necessarily have any predetermined association with the term LATA used by other exchange carriers.

Logical Channel

The term "Logical Channel" denotes a communication channel which allows two-way simultaneous transmission of data packets through the network. No circuit capability is preassigned to a logical channel. Capacity is made available as the data is transmitted. Each virtual connection utilizes one logical channel.

ACCESS SERVICE

2. General Regulations (Cont'd)**2.6 Definitions (Cont'd)****Loop Around Test Line**

The term "Loop Around Test Line" denotes an arrangement utilizing a Telephone Company central office to provide a means to make certain two-way transmission tests on a manual basis. This arrangement has two central office terminations, each reached by means of separate telephone numbers and does not require any specific customer premises equipment. Equipment subject to this test arrangement is at the discretion of the customer.

Loss Deviation

The term "Loss Deviation" denotes the variation of the actual loss from the designed value.

ACCESS SERVICE

2. General Regulations (Cont'd)**2.6 Definitions (Cont'd)**Message

The term "Message" denotes a "call" as defined preceding.

Milliwatt (102 Type) Test Line

The term "Milliwatt (102 Type) Test Line" denotes an arrangement in an end office which provides a 1004 Hz tone at 0 dBm0 for one-way transmission measurements towards the customer's premises from the Telephone Company end office.

Mobile Telephone Switching Office (MTSO)

The term "Mobile Telephone Switching Office (MTSO)" denotes a Cellular Mobile Carrier (CMC) Switching System that is used to originate or terminate calls on the CMC network, or originate or terminate calls between the CMC and the public switched telephone network.

Network Control Signaling

The term "Network Control Signaling" denotes the transmission of signals used in the telecommunications system which perform functions such as supervision (control, status, and charge signals), address signaling (e.g., dialing), calling and called number identifications, rate of flow, service selection error control and audible tone signals (call progress signals indicating re-order or busy conditions, alerting, coin denominations, coin collect and coin return tones) to control the operation of the telecommunications system.

Node

The term "Node" denotes a SONET ring service element that designates either a customer designated location or a Telephone Company wire center location on the SONET ring. It also denotes the location/address of where a channelized service originates or terminates on a ring.

Non-Competitive County

The term "Non-Competitive County" denotes a geographic unit of a county or county-equivalent that failed a competitive market test specified by the FCC (excluding those that were granted Phase II, Level 2 pricing flexibility prior to June 1, 2017 and thus are defined as "Competitive Counties").

(N)
|
(N)

ACCESS SERVICE

2. General Regulations (Cont'd)**2.6 Definitions (Cont'd)****Nonsynchronous Test Line**

The term "Nonsynchronous Test Line" denotes an arrangement in step-by-step end offices which provides operational tests which are not as complete as those provided by the synchronous test lines, but can be made more rapidly.

North American Numbering Plan

The term "North American Numbering Plan" denotes a three digit area (Numbering Plan Area) code and a seven-digit telephone number made up of a three-digit Central office code plus a four-digit station number.

ACCESS SERVICE

2. General Regulations (Cont'd)**2.6 Definitions (Cont'd)**Off-hook

The term "off-hook" denotes the active condition of Switched Access or a Telephone Exchange Service Line.

On-hook

The term "On-hook" denotes the idle condition of Switched Access or a Telephone Exchange Service line.

Open Circuit Test Line

The term "Open Circuit Test Line" denotes an arrangement in an end office which provides an ac circuit termination of a trunk or line by means of an inductor of several Henries.

Optical Carrier Rate (OC-N)

The term "OC-N" denotes an Optical Networking transmission signal, speed, line rate, commonly referred to as follows:

<u>OC-N Rate</u>	<u>Bandwidth Capacity</u>
OC-1	51.84 Mbps
OC-3	155.52 Mbps
OC-12	622.08 Mbps
OC-24	1.25 Gbps
OC-48	2.488 Gbps

ACCESS SERVICE

2. General Regulations (Cont'd)**2.6 Definitions (Cont'd)**Originating Direction

The term "Originating Direction" denotes the use of access service for the origination of calls from an End User Premises to an IC Premises.

OZZ Code

The term "OZZ Code" denotes the service class routing code of a multifrequency (MF) call that indicates the interexchange carrier trunk group to which the traffic will be routed (e.g., 0+, 0-, 500, 900, etc.).

Pay Telephone

The term "Pay Telephone" denotes Telephone Company provided instruments and related facilities that are available to the general public for public convenience and necessity, including public and semipublic telephones, and coinless telephones.

Payload

The term "Payload" denotes the portion of the SONET signal available to carry service signals such as DS0, DS1, and DS3.

Phase Jitter

The term "Phase Jitter" denotes the unwanted phase variations of a signal.

ACCESS SERVICE

2. General Regulations (Cont'd)**2.6 Definitions (Cont'd)****Physical EIS**

The term "Physical EIS" denotes an offering that enables customers to place equipment needed to terminate basic transmission facilities, including optical terminating equipment and multiplexers, within or upon the Telephone Company's wire center or Telephone Company access tandem buildings, use such equipment to connect customer's fiber optic systems or microwave radio transmission facilities (where reasonably feasible) with the local exchange carrier's equipment and facilities used to provide interstate switched and special access services.

Plant Test Date

The term "Plant Test Date" denotes the date on which installation is completed and the Telephone Company to customer testing can begin.

Point of Termination

The term "Point of Termination" denotes the point of demarcation at a customer-designated premises at which the Telephone Company's responsibility for the provision of Access Service ends.

Premises

The term "Premises" denotes a building or buildings on continuous property (except Railroad Right-of-Way, etc.) not separated by a public highway.

Release Message

The term "Release Message" denotes an SS7 Message sent in either direction to indicate that a specific circuit is being released.

ACCESS SERVICE

2. General Regulations (Cont'd)**2.6 Definitions (Cont'd)****Remote Switching Modules and/or Remote Switching Systems**

The term "Remote Switching Modules and/or Remote Switching Systems" denotes remotely controlled electronic end office switches which obtain their call processing capability from an ESS-type Host Office. The Remote Switching Modules and/or Remote Switching Systems cannot accommodate direct trunks to an IC.

Return Loss

The term "Return Loss" denotes a measure of the similarity between the two impedances at the junction of two transmission paths. The higher the return loss, the higher the similarity.

ACCESS SERVICE

2. General Regulations (Cont'd)**2.6 Definitions (Cont'd)****Registered Equipment**

The term "Registered Equipment" denotes the customer's premises equipment which complies with and has been approved within the Registration Provisions of Part 68 of the FCC's Rules and Regulations.

Service Control Point

The term "Service Control Point (SCP)" denotes an SS7 network control interface element between the Telephone Company's SS7 network and one or more data bases.

Secure Socket Layer (SSL)

The term "Secure Socket Layer ("SSL)" denotes a security protocol that provides data encryption, server authentication, message integrity, and optional client authentication for a TCP/IP connection.

Service Date

The term "Service Date" denotes the date that the service is made available to the customer. A confirmed ASR is required to establish a service date.

Service Switching Point (SSP)

The term "Service Switching Point" (SSP) denotes a signal point equipped with the ability to halt call process, formulate and send a SS7 query to a remote location and route the call based on information contained in the response.

Serving Wire Center

That Telephone Company designated wire center serving the customer's designated premises and used for mileage measurement to determine local transport or circuit mileage charges for Access Service.

Seven Digit Manual Test Line

The term "Seven Digit Manual Test Line" denotes an arrangement which allows the Customer to select balance, milliwatt and synchronous test lines by manually dialing a seven digit number over the associated access connection.

Shortage of Facilities or Equipment

The term "Shortage of Facilities or Equipment" denotes a condition which occurs when the Telephone Company does not have appropriate cable, switching capacity, bridging or, multiplexing equipment, etc., necessary to provide the Access service requested by the customer.

ACCESS SERVICE

2. General Regulations (Cont'd)**2.6 Definitions (Cont'd)**Short Circuit Test Line

The term "Short Circuit Test Line" denotes an arrangement in an end office which provides for an ac short circuit termination of a trunk or line by means of a capacitor of at least four microfarads.

Signal-to-C-Notched Noise Ratio

The Term "Signal-to-C-Notched Noise Ratio" denotes the ratio in dB of a test signal to the corresponding C-Notched Noise.

Signaling Point

The term "Signaling Point (SP)" denotes an SS7 network interface element capable of originating and/or terminating SS7 messages.

Signaling System 7 (SS7)

The term "Signaling System 7 (SS7)" denotes the layered protocol used for standardized common channel signaling in the United States.

Signal Transfer Point (STP)

The term "Signal Transfer Point (STP)" denotes a packet switch which provides access to the Telephone Company's SS7 network and performs SS7 message signal routing and screening. The technical interface specifications, transmission specifications, and diversity requirements for interconnecting to the Telephone Company's SS7 network at the STP are as described in Technical Reference GR-905-CORE, Issue 11.

Signal Transfer Point (STP) Port

The term "Signal Transfer Point (STP) Port" denotes the physical point of termination and interconnection to the STP.

Singing Return Loss

The term "Singing Return Loss" denotes the frequency weighted measure of return loss at the edges of the voiceband (200 to 500 Hz and 2500 to 3200 Hz), where singing (instability) problems are most likely to occur.

ACCESS SERVICE

2. General Regulations (Cont'd)**2.6 Definitions (Cont'd)****SONET**

The term "SONET" (Synchronous Optical Network) denotes a family of fiber optic transmission bit rates starting at 51.84 Mbps, designed to provide the flexibility needed to transport many digital signals with different capacities.

Statistical Multiplexing

The term "Statistical Multiplexing" denotes a technique in which timeslots are dynamically allocated on the basis of need rather than being predetermined. The data is typically transmitted on a first come, first served basis.

Subtending End Office of the Telephone Company Access Tandem

The term "Subtending End Office of the Telephone Company Access Tandem" denotes an end office that has final trunk group routing through the Telephone Company access tandem.

Synchronous Test Line

The term "Synchronous Test Line" denotes an arrangement in an end office which performs marginal operational tests of supervisory and ring-tripping functions equivalent information needed to perform tandem switching functions.

Synchronous Transport Signal (STS)

STS-1 has the capacity to transport up to twenty-eight (28) DS1s or one (1) DS3.

Synchronous Transport Signal (STS1)

The term "Synchronous Transport Signal" (STS1) denotes a 51.84 Mbps signal that is the electrical equivalent of the OC1 or a DS3 with additional Mbps devoted to SONET overhead information. An STS1 can carry a DS3 or 28 DS1s when specifically formatted (mapped). These DS1s may be accessed off-ring using DS3 to DS1 Multiplexing as set forth in Section 20 or at an enhanced node via a DS3 Transmux port.

ACCESS SERVICE

2. General Regulations (Cont'd)**2.6 Definitions (Cont'd)**Terminating Direction

The term "Terminating Direction" denotes the use of Access Service for the completion of calls from an IC premises to an End User Premises.

Toll VoIP-PSTN Traffic

The term "Toll VoIP-PSTN Traffic" denotes a customer's interexchange voice traffic exchanged with the Telephone Company in Time Division Multiplexing format over Public Switched Telephone Network (PSTN) facilities, which originates and/or terminates in Internet Protocol (IP) format. "Toll VoIP-PSTN Traffic" originates and/or terminates in IP format when it originates from and/or terminates to an end user customer of a service that requires IP-compatible customer premises equipment.

(N)(X)

| |
| |
| |
| |
| |
(N)(X)Transmission Measuring (105 Type) Test Line/Responder

The term "Transmission Measuring (105 Type) Test Line/Responder" denotes an arrangement in an end office which provides far-end access to a responder and permits two-way loss and noise measurements to be made on trunks from a near end office.

Transmission Path

The term "Transmission Path" denotes an electrical path capable of transmitting signals within the range of the service offering, e.g., a voice grade transmission path is capable of transmitting voice frequencies within the approximate range of 300 to 3000 Hz. A transmission path is comprised of physical or derived facilities consisting of any form or configuration of plant typically used in the telecommunications industry.

Transmuxing

The term "Transmuxing" denotes the function of a DSR DS3 Transmux port which performs a DS3 to DS1 conversion at a DSR node. The DS3 to DS1 conversions allows a single DSR DS3 Transmux port to be associated with up to twenty-eight (28) VT1.5 mapped DSR DS1 ports. Transmuxing within the DSR network retains DS1 visibility allowing for full, proactive maintenance capability of DS1 signals.

Trunk

The term "Trunk" denotes a communications path connecting two switching systems in a network, used in the establishment of an end-to-end connection.

Trunk Group

The term "Trunk Group" denotes a set of trunks which are traffic engineered as a unit for the establishment of connections between switching systems in which all of the communications paths are interchangeable.

(X) Issued under authority of Special Permission No. 11-021.

Issued: December 20, 2011

Effective: December 31, 2011

(This page filed under Transmittal No. 22)
Vice President, Government and Regulatory Affairs
180 S. Clinton Ave., Rochester, NY 14646

ACCESS SERVICE

2. General Regulations (Cont'd)**2.6 Definitions (Cont'd)**Trunk Side Connection

The term "Trunk Side Connection" denotes the connection of a transmission path to the trunk side of a local exchange switching system.

Two-Wire to Four-Wire Conversion

The term "Two-Wire to Four-Wire Conversion" denotes an arrangement which converts a four-wire transmission path to a two-wire transmission path to allow a four-wire facility to terminate to a two-wire entity (e.g., a central office switch).

Uniform Service Order Code

The term "Uniform Service Order Code" denotes a three or five character alphabetic, numeric, or an alphanumeric code that identifies a specific item of service or equipment. Uniform Service Order Codes are used in the Telephone Company billing system to generate recurring rates and nonrecurring charges.

V&H Coordinates

The term "V and H Coordinates Method" denotes a method of computing airline miles between two points by utilizing an established formula which is based on the vertical and horizontal coordinates of the two points.

Virtual EIS

The term "Virtual EIS" denotes an offering that enables customers to designate or specify equipment needed to terminate basic transmission facilities, including optical terminating equipment and multiplexers, to be located within or upon the Telephone Company's wire center or Telephone Company's access tandem buildings, and dedicated to such customer's use.

(D)(X)
| |
| |
| |
| |
(D)(X)

(X) Issued under authority of Special Permission No. 11-021.

Issued: December 20, 2011

Effective: December 31, 2011

(This page filed under Transmittal No. 22)
Vice President, Government and Regulatory Affairs
180 S. Clinton Ave., Rochester, NY 14646

ACCESS SERVICE

2. General Regulations (Cont'd)**2.6 Definitions (Cont'd)****WATS Serving Office**

"WATS Serving Office" denotes a Telephone Company switching office capable of performing the optional screening functions used in Combined Access Service Arrangements.

Wire Center

The term "Wire Center" denotes (1) a building in which one or more central offices, including end office switches, used for the provision of Telephone Exchange Services, are located, or (2) in the case of a centralized Telephone Company equal access tandem arrangement, a building in which Telephone Company access facilities are located for purposes of interconnection to customer premises.

ACCESS SERVICE

2. General Regulations (Cont'd)2.7 Service Level Agreements2.7.1 Basic Service Level Agreements (Basic SLAs)

Regulations pertaining to Basic SLAs are contained in this tariff as specified following:

<u>Description</u>	<u>Tariff Reference</u>
Credit Allowance for Service Interruptions	2.7.1.1

(C)

ACCESS SERVICE

2. General Regulations (Cont'd)
- 2.7 Service Level Agreements (Cont'd)
- 2.7.1 Basic Service Level Agreements (Basic SLAs) (Cont'd)
- 2.7.1.1 Credit Allowance for Service Interruption
- (A) General

A service is interrupted when it becomes unusable to the customer because of failure of a facility component used to furnish service under this tariff or in the event that the protective controls applied by the Telephone Company result in the complete loss of service by the customer as set forth in 6.4(A) following. An interruption period starts when an inoperative service is reported by the customer to the Telephone Company and ends when the service is operative. The customer is responsible for sectionalizing trouble to the Telephone Company facilities and/or equipment as set forth in 2.3.10 preceding.

Subject to Section 2.7.4(B) following, in case of an interruption to any service, credit allowance for the period of interruption shall be calculated as set forth in this Section 2.7.1.1.

The credit allowance for an interruption or for a series of interruptions shall not exceed the monthly rate and minimum monthly usage charge for the service interrupted in any one monthly billing period.

For purposes of this section of the tariff, "major fraction" is defined as that time period representing one-half or more of the incremental time period used to apply the credit allowance for those specific services listed in (B) following.

Service interruptions for Specialized Service or Arrangements provided under the provisions of 12 following shall be administered in the same manner as those set forth in this Section 2.7.1.1 unless other regulations are specified with the individual case filing.

- (1) An out of service credit will apply for the following Optical Networking rate elements, where applicable, should the service be interrupted due to the Telephone Company's system's failure to switch to protected electronics and/or facilities within one (1) second in those locations connected to the Telephone Company surveillance system unless such interruptions are a result of conditions outside the Telephone Company's control:
- Shared Ring Connect
 - Ring Connect
 - LAN-wide Premium Transport
 - Ring-per-mile Transport
 - ON-net Banded Optical Transport provisioned via a ring topology
 - Custom Connect configured via a Ring topology.
- (2) Credit will be predicated on information provided by the Telephone Company's and the customer's network surveillance systems associated with this service arrangement. The Telephone Company and the customer shall each have the opportunity to perform an annual inspection of the other party's network surveillance system to confirm its accuracy. The out-of-service credit will be calculated based on the monthly rate element charges of that portion of the inter-office network rendered inoperative. A maximum limit of one month recurring charge per rate element will be allotted for a interruption or series of interruptions within any one billing period.

ACCESS SERVICE

2. General Regulations (Cont'd)**2.7 Service Level Agreements (Cont'd)****2.7.1 Basic Service Level Agreements (Basic SLAs) (Cont'd)****2.7.1.1 Credit Allowance for Service Interruption (Cont'd)****(A) General (Cont'd)**

(3) Any outage of Single Route Custom Connect services of four (4) hours or more due to a company facility failure will result in a credit of 100% of the monthly rate for the service. Any outage of Diverse Route Custom Connect services of one (1) hour or more due to a company facility failure will result in a credit of 100% of the monthly rate for the service. These credits can not exceed the monthly charge in a single month's billing period.

(4) For Dedicated SONET Optical Transport Service (DSOTS) nodes and network optimization, any single service outage of four hours or more due solely to a Telephone Company facility failure will result in a credit of 100% of the monthly rates for the applicable DSOTS node or network optimization devices affected. Only one such credit is allowed in a single month's billing period.

For DSOTS Optical Transport Channels, the following credits will be applied.

- For protected Optical Transport Channels, any Telephone Company facility failure which is not restored within 1 minute will result in a credit of 100% of the monthly rate for the applicable protected optical channels affected. Only one such credit is allowed in a single month's billing period.

- For unprotected Optical Transport Channels, no credit applies for a service outage on these channels for which no protection is provided by the Telephone Company.

- When one or more channels utilizing a multi-port interface card require(s) maintenance, all channels provisioned over that multi-port interface card will be interrupted. No credit will be made for such periods during which all channels on the multi-port interface card are interrupted to allow the Telephone Company to perform required maintenance.

(5) For Ethernet Private Line Service, any outage due solely to a Telephone Company facility failure will result in a credit of 100 % of the monthly recurring charges for the portion of the service affected. Only one such credit is allowed in a single month's billing period. The following credits will be applied.

- For protected On-Net Channel Extensions and On-Net Channel Mileage, a credit of 100% of one month's recurring charge for the Ethernet Private Line service will apply for any outage that exceeds one minute. No more than one such credit is given in 1 monthly billing cycle.

- For unprotected On-Net Channel Extensions a credit of 100% of one month's recurring charge for the Ethernet Private Line service will apply if the total outage time exceeds 4 hours.

- For Ethernet Private line services that consist of both unprotected and protected service components, the credit allowance that applies for each outage will be based on the credit allowance provisions for unprotected channels.

ACCESS SERVICE

2. General Regulations (Cont'd)
- 2.7 Service Level Agreements (Cont'd)
- 2.7.1 Basic Service Level Agreements (Basic SLAs) (Cont'd)
- 2.7.1.1 Credit Allowance for Service Interruption (Cont'd)
- (A) General (Cont'd)
- (6) For Dedicated SONET Ring (DSR) Service, any outage greater than one (1) minute and due solely to a Telephone Company facility failure will result in a credit of 100% of the monthly rate for the applicable rate elements of the affected service. Only one such credit is allowed in a single month's billing period. When DSR as set forth in Section 20.2 following is arranged with subtending rings, a credit allowance for a service interruption is applied independently to each ring. For example, if the main DSR becomes interrupted and is eligible for a credit allowance, no credit allowance is due on the subtending ring(s) associated with that main ring unless service on the subtending ring(s) is also interrupted.
- (7) For Entrance Facilities, any single service outage of one (1) hour or more and due solely to a Telephone Company facility failure will result in a credit of one hundred percent (100%) of the monthly rate for the applicable DSEF rate elements affected. Only one such credit is allowed in a single month's billing period.
- (8) The credit allowance for all other Optical Networking access services will be as shown in 2.7.1.1(B).
- (B) Special Access Services
- (1) For Special Access Services (other than Program Audio and Video Digital Transport Service TV-1 Analog/ Services) and for Switched Access Entrance Facilities, Direct-Trunked Transport and Multiplexing services, no credit shall be allowed for an interruption of less than 30 minutes. The customer shall be credited for an interruption of 30 minutes or more at the rate of 1/1440 of the monthly charges for the facility or service for each period of 30 minutes or major fraction thereof that the interruption continues.
- The monthly charges used to determine the credit shall be as follows:
- (a) For two point services, the monthly charge subject to credit shall be the total of all the monthly rate element charges associated with the service (i.e., two circuit terminations, circuit mileage and optional features and functions).
- (b) For multipoint services, the monthly charge subject to credit shall be only the total of all the monthly rate element charges associated with that portion of the service that is inoperative (i.e., a circuit termination per customer premises, circuit mileage and optional features and functions).
- (c) For multiplexed services, the monthly charge subject to credit shall be the total of all the monthly rate element charges associated with that portion of the service that is inoperative. When the facility which is multiplexed or the multiplexer itself is inoperative, the monthly charge shall be the total of all the monthly rate element charges associated with the service (i.e., the circuit termination, circuit mileage and optional features and functions, including the multiplexer on the facility to the hub, and the circuit terminations, circuit mileage and optional features and functions on the individual services from the hub). When the service which rides a circuit of the multiplexed facility is inoperative, the monthly charge shall be the total of all the monthly rate element charges associated with that portion of the service from the Hub to a customer premises (i.e., circuit termination, circuit mileage and optional features and functions).

ACCESS SERVICE

- 2. General Regulations (Cont'd)
- 2.7 Service Level Agreements (Cont'd)
- 2.7.1 Basic Service Level Agreements (Basic SLAs) (Cont'd)
- 2.7.1.1 Credit Allowance for Service Interruption (Cont'd)
- (B) Special Access Services (Cont'd)
 - (2) For Program Audio and Video Digital Transport ServiceTV-1 Analog Special Access Services, no credit shall be allowed for an interruption of less than 30 seconds. The customer shall be credited for an interruption of 30 seconds or more as follows:
 - (a) For two-point services, when monthly rates are applicable, the credit shall be at the rate of 1/8640 of the monthly charges for the service for each period of 5 minutes or major fraction thereof that the interruption continues.
 - (b) For two-point services, when daily rates are applicable, the credit shall be at the rate of 1/288 of the daily charges for the service for each period of 5 minutes or major fraction thereof that the interruption continues.
 - (c) For multipoint services, when monthly rates are applicable, the credit shall be at the rate of 1/8640 of the monthly charges for each circuit termination, circuit mileage and optional features and functions that is inoperative for each period of 5 minutes or major fraction thereof that the interruption continues.
 - (d) For multipoint services, when daily rates are applicable, the credit shall be at the daily rate of 1/288 of the daily charges for each circuit termination, circuit mileage and optional features and functions that is inoperative for each period of 5 minutes or major fraction thereof that the interruption continues.
 - (e) For multipoint services, the credit for the monthly or daily charges includes the charges for the distribution amplifier only when the distribution amplifier is inoperative.
 - (f) When two or more interruptions occur during a period of 5 consecutive minutes, such multiple interruptions shall be considered as one interruption.
 - (3) For certain Special Access services (Wideband Digital, WD1-3; Digital Data Access, DA1-4; and High Capacity, HC1), any period during which the error performance is below that specified for the service will be considered as an interruption.

ACCESS SERVICE

- 2. General Regulations (Cont'd)
- 2.7 Service Level Agreements (Cont'd)
- 2.7.1 Basic Service Level Agreements (Basic SLAs) (Cont'd)
- 2.7.1.1 Credit Allowance for Service Interruption (Cont'd)
- (B) Special Access Services (Cont'd)

- (4) Except as noted, all Special Access Services will be eligible for a credit allowance for each occurrence of a service interruption period greater than 30 minutes. The maximum credit allowance will be \$200.00 for each out of service condition within the Telephone Company's facilities and will not exceed the monthly charge for the interrupted service. The credit allowance will not be applied more than once per calendar month. This credit allowance is applicable in all jurisdictions. The credit allowance is in addition to the credit allowance in 2.7.1.1(B)(1). A credit allowance will not be extended in accordance with conditions in 2.1.3 and 2.7.4(B) for repair of Telephone Company owned facilities.

The exceptions to this credit allowance are Program Audio Service - Daily Rates in 7.6.5, Video Digital Transport Service tTV-1 Analog Services in 7.7, Individual Case Basis Services in 7.12 and Specialized Service Arrangements in 12.

* Section 2.7.1.1(B)(4) is not available for Special Access Services installed after June 1, 2006. The preceding sentence applies to both Special Access Services that are provided on a month-to-month basis and Special Access Services that are provided under a Discount Plan (as defined below).

For Special Access Services installed on or before June 1, 2006, Section 2.7.1.1(B)(4) will not be available as follows:

For Special Access Services provided on a month-to-month basis, after June 1, 2006.

For Special Access Services provided under a Discount Plan (as defined below), after the date of expiration, termination, or cancellation of the Discount Plan commitment period that is in effect on June 1, 2006.

For Special Access Services provided under a Discount Plan (as defined below) that are covered by a National Service Level Agreement Plan, during the period that a customer participates in such National Service Level Agreement Plan. The customer has the option to subscribe to a National Service Level Agreement Plan as set forth in Section 2.7.3 following. Nothing in this paragraph (c) shall in any way limit the effect of paragraph (b) preceding.

As used in this note, "Discount Plan" means any tariff arrangement for the provision of Special Access Services other than on a month-to-month basis.

For any month for which a Special Access Service receives a credit allowance under Section 2.7.1.1(B)(4), that Special Access Service shall not receive a credit allowance under Section 2.7.1.1(B)(5).

ACCESS SERVICE

- 2. General Regulations (Cont'd)
- 2.7 Service Level Agreements (Cont'd)
- 2.7.1 Basic Service Level Agreements (Basic SLAs) (Cont'd)
- 2.7.1.1 Credit Allowance for Service Interruption (Cont'd)
- (B) Special Access Services (Cont'd)

- (5) For certain Special Access services, a Special Access Service Guarantee (SASG) credit allowance will apply in the event that such services experience a service interruption of four (4) or more consecutive hours except as specified in 2.7.4(B) following. The SASG credit allowance will apply to Voice Grade, monthly Program Audio and Video Digital Transport Service t TV-1 Analog, Metallic, Telegraph, Wideband Data, Digital Data Service (DDS), and High Capacity DS1 & DS3 Special Access services (collectively, Special Access Services).

The customer has the option to subscribe to a National SLA Plan as set forth in Section 2.7.3 following. When a customer subscribes to a National SLA plan, credit allowances under this Section 2.7.1.1(B)(5) do not apply to services covered by the National SLA Plan.

If a Special Access Service is eligible for an SASG credit allowance, the Telephone Company shall provide the applicable credit amount as set forth in the table following. The Telephone Company shall bill customer the applicable monthly rate for the Special Access Service, and if customer is eligible to receive the SASG credit allowance, customer shall receive the SASG credit in a later invoice. Except as stated in this tariff, the SASG credit allowance is in addition to any other credit allowances available under this Section 2.7.1.1. The maximum amount of all credit allowances available under this Section 2.7.1.1 for a Special Access Service for a given billing period shall not exceed the total applicable monthly charge paid by the customer for such Special Access Service. The monthly charge will consist of all applicable rate elements charged to the circuit experiencing the service interruption. The SASG credit allowance can only be applied once per month on a per circuit basis. For multi-point circuits, the SASG credit allowance will apply to each leg of the circuit that experiences a service interruption.

ACCESS SERVICE

2. General Regulations (Cont'd)
- 2.7 Service Level Agreements (Cont'd)
- 2.7.1 Basic Service Level Agreements (Basic SLAs) (Cont'd)
- 2.7.1.1 Credit Allowance for Service Interruption (Cont'd)
- (B) Special Access Services (Cont'd)
- (5) (Cont'd)

The SASG credit allowance for each applicable service is listed below and applies to all states:

<u>Service</u>	<u>SASG (per circuit)</u>
Metallic	\$10.00
Telegraph, Voice Grade	20.00
Program Audio (monthly, full -time only)	
200 – 3500 Hz	10.00
100 – 5000 Hz	15.00
50 – 8000 Hz	20.00
50 – 15000 Hz	25.00
Video Digital Transport Service t TV-1 Analog (monthly)	100.00
Wideband Data	100.00
Digital Data Service (DDS)	
2.4 kbps	40.00
4.8 kbps	45.00
9.6 kbps	50.00
19.2 kbps	55.00
56.0 kbps	60.00
64.0 kbps	65.00
High Capacity	
DS1	160.00
DS3	400.00

ACCESS SERVICE

- 2. General Regulations (Cont'd)
- 2.7 Service Level Agreements (Cont'd)
- 2.7.1 Basic Service Level Agreements (Basic SLAs) (Cont'd)
- 2.7.1.1 Credit Allowance for Service Interruption (Cont'd)
- (C) Switched Access Service

For Switched Access Service, other than Entrance Facilities, Direct-Trunked Transport and Multiplexing, no credit shall be allowed for an interruption of less than 24 hours. The customer shall be credited for an interruption of 24 hours or more at the rate of 1/30 of any applicable monthly charge, assumed usage, or minimum monthly usage charge for each period of 24 hours or major fraction thereof that the interruption continues.

For Switched Access service interrupted by an NXX isolation a credit will be given the billed customer of record utilizing the following formula:

300 Minutes of Use X the appropriate switched access rate X the number of trunks out of service = the credit allowance

NXX isolation is defined as a situation whereby a customer in an NPA-NXX is unable to originate a call to the carrier network and/ or receive a call from the carrier network.

The credit will apply when an out of service condition of 30 minutes or more occurs within the Telephone Company's switched facilities. The credit allowance will not be applied more than once per calendar month. A credit allowance will not be extended in accordance with conditions in 2.1.3 and 2.7.4(B) for repair of Telephone Company owned facilities.

Switched Access Service Entrance Facilities, Direct-Trunked Transport and Multiplexing will be eligible for a credit allowance for each occurrence of a service interruption period greater than 30 minutes. The maximum credit allowance will be \$200.00 for each out of service condition within the Telephone Company's facilities. The credit allowance will not exceed the monthly charge for the interrupted service and will not be applied more than once per calendar month. This credit allowance is applicable in all jurisdictions. A credit allowance will not be extended in accordance with conditions in 2.1.3 and 2.7.4(B) for repair of Telephone Company owned facilities.

For Common Channel Signaling System 7 (CCS7) Access Service, described in Section 6.2.7, a credit allowance will be made for an interruption period of 30 minutes or more. The allowance will be calculated at the rate of 1/1440 of the monthly charge for the portion of the service affected, for each 30 minutes or major fraction thereof that the interruption continues.

ACCESS SERVICE

- 2. General Regulations (Cont'd)
- 2.7 Service Level Agreements (Cont'd)
- 2.7.1 Basic Service Level Agreements (Basic SLAs) (Cont'd)
- 2.7.1.1 Credit Allowance for Service Interruption (Cont'd)

(C) Switched Access Service (Cont'd)

Switched Access Service Entrance Facilities, Direct-Trunked Transport and Multiplexing will be eligible for a credit allowance for each occurrence of a service interruption period greater than 30 minutes. The maximum credit allowance will be \$200.00 for each out of service condition within the Telephone Company's facilities. The credit allowance will not exceed the monthly charge for the interrupted service and will not be applied more than once per calendar month. This credit allowance is applicable in all jurisdictions. A credit allowance will not be extended in accordance with conditions in 2.1.3 and 2.7.4(B) for repair of Telephone Company owned facilities.

For Common Channel Signaling System 7 (CCS7) Access Service, described in Section 6.2.7, a credit allowance will be made for an interruption period of 30 minutes or more. The allowance will be calculated at the rate of 1/1440 of the monthly charge for the portion of the service affected, for each 30 minutes or major fraction thereof that the interruption continues.

(D) When a Credit Allowance Does Not Apply

Services will not be eligible for credits when any of the conditions set forth in Section 2.7.4(B) following exist.

(E) Use of an Alternative Service Provided by the Telephone Company

Should the customer elect to use an alternative service provided by the Telephone Company during the period that a service is interrupted, the customer must pay the tariffed rates and charges for the alternative service used.

(F) Temporary Surrender of a Service

In certain instances, the customer may be requested by the Telephone Company to surrender a service for purposes other than maintenance, testing or activity relating to a service order. If the customer consents, a credit allowance will be granted. The credit allowance will be 1/440 of the monthly rate for each period of 30 minutes or fraction thereof that the service is surrendered. In no case will the credit allowance exceed the monthly rate for the service surrendered in any one monthly billing period.

ACCESS SERVICE

- 2. General Regulations (Cont'd)
- 2.7 Payment Arrangements and Credit Allowances (Cont'd)
- 2.7.1 Basic Service Level Agreements (Basic SLAs) (Cont'd)
- 2.7.1.2 Reserved for Future Use

(C)

(C)

ACCESS SERVICE

2. General Regulations (Cont'd)2.7 Service Level Agreements (Cont'd)2.7.2 Enhanced Service Level Agreements (Enhanced SLAs)

Regulations pertaining to Enhanced SLAs are contained in this tariff as specified following:

<u>Description</u>	<u>Tariff Reference</u>	
Integrated Optical Service Rider SLAs	2.7.2.1	
(Reserved for Future Use)	2.7.2.2	
(Reserved for Future Use)	2.7.2.3	(D)
(Reserved for Future Use)	2.7.2.4	(D)

ACCESS SERVICE

2. General Regulations (Cont'd)
- 2.7 Service Level Agreements (Cont'd)
- 2.7.2 Enhanced Service Level Agreements (Enhanced SLAs) (Cont'd)
- 2.7.2.1 Integrated Optical Service Rider SLAs
- (A) General
- (1) With the exception of those Integrated Optical Service Riders provided subject to Section 23.1.3 following, the SLAs set forth in this Section 2.7.2.1 apply to all other Integrated Optical Service Riders set forth in Section 23.1 following ("Qualifying Services").
- (2) The monthly recurring rate(s) for the Qualifying Service are the Integrated Optical Service Rider Appearances.
- (3) To receive credit, the Telephone Company must receive from the customer a written request for credit within sixty (60) calendar days of the end of the calendar month in which the SLA threshold was missed. The customer's request for credit must be submitted to the appropriate Telephone Company in a manner mutually agreed upon by the Telephone Company and the customer. The request must include a list of the identification numbers of all impacted circuits.
- (B) Availability
- (1) Availability refers to the percentage of time over a calendar month that a Qualifying Service is able to transmit data over the Telephone Company's integrated optical service. A Qualifying Service is unavailable if data cannot be transmitted because of a failure of a facility component within the Telephone Company's integrated optical service that is used to furnish the Qualifying Service provided under this Tariff.
- (2) Availability is calculated as follows: $\text{Availability} = (1440 \times \text{Number of Days in Month}) - (\text{Number of Minutes the Service is unavailable during Month}) / (1440 \times \text{Number of Days in Month})$. The number of minutes the Service is unavailable is as determined by the Telephone Company.
- (3) The Telephone Company threshold for Availability under this Section in a calendar month is 99.999%.
- (4) If Availability under this Section is less than the threshold, then a credit equal to twenty-five percent (25%) of the monthly recurring rate(s) for the affected Qualifying Service applies. Only one (1) such credit is allowed in a single month's billing period.
- (C) Mean Time to Restore (MTTR)
- (1) MTTR applies to an interruption of service that is within the Telephone Company's integrated optical service.
- (2) Interruption of service is defined as a condition which renders a Qualifying Service unusable to the customer (i.e., data cannot be transmitted) because of a failure of a facility within the Telephone Company's integrated optical service that is used to furnish the Qualifying Service under this tariff. The Telephone Company will initiate a trouble ticket on all DS1 Qualifying Service interruptions reported by the customer. The Telephone Company will initiate a trouble ticket on all DS3 Qualifying Service interruptions reported by the customer and/or detected by the Telephone Company's network.

ACCESS SERVICE

2. General Regulations (Cont'd)
- 2.7 Service Level Agreements (Cont'd)
- 2.7.2 Enhanced Service Level Agreements (Enhanced SLAs) (Cont'd)
- 2.7.2.1 Integrated Optical Service Rider SLAs (Cont'd)
- (C) Mean Time to Restore (MTTR) (Cont'd)
- (3) MTTR for a calendar month shall be the average of all Time to Restore (TTR), as calculated by the Telephone Company. The TTR is the period of time the Qualifying Service is unavailable between the opening and closing of the trouble ticket, minus any stop clock time that was logged against the trouble ticket. Stop clock time includes, by way of example, the following times:
- Periods when customer testing is occurring.
 - Periods when the customer is working on its own Customer Premises Equipment (CPE) and has not yet released the Qualifying Service to the Telephone Company for maintenance, testing or repair.
 - Periods when the Telephone Company is awaiting customer authorization to commence work on the Qualifying Service.
 - Periods when the Telephone Company is denied access to premises or facilities necessary to diagnose, repair, or test a Qualifying Service.
 - Periods following repair of the Qualifying Service when the ticket is held open by the customer to ensure the trouble is resolved.
- (4) MTTR is calculated by summing TTR for all measured tickets for the customer for the calendar month and dividing by the total number of tickets for that customer during that month.
- (5) MTTR excludes any subsequent reports (i.e., additional customer inquiries while the trouble is pending), CPE troubles, trouble found on the customer's side of the point of demarcation, no trouble found, troubles closed due to customer action, force majeure events, and troubles repaired by the Telephone Company prior to receipt of a trouble report on that Qualifying Service.
- (6) The threshold for MTTR in a calendar month is 2.5 hours for Qualifying Services.

ACCESS SERVICE

- 2. General Regulations (Cont'd)
- 2.7 Service Level Agreements (Cont'd)
- 2.7.2 Enhanced Service Level Agreements (Enhanced SLAs) (Cont'd)
- 2.7.2.1 Integrated Optical Service Rider SLAs (Cont'd)
- (C) Mean Time to Restore (MTTR) (Cont'd)
 - (7) If the MTTR is greater than 2.5 hours over the calendar month for all of customer's Qualifying Services, then a credit equal to twenty-five percent (25%) of the monthly recurring rate(s) for the affected Qualifying Service applies for those Qualifying Services that were the subject of a trouble ticket during the measured calendar month whose TTR exceeded 2.5 hours. Only one (1) such credit is allowed in a single month's billing period. If the MTTR is 2.5 hours or less on all of customer's Qualifying Services, then no credit applies to any Qualifying Service, even if the TTR on a particular Qualifying Service exceeded such threshold.
- (D) Qualifying Services will not be included in threshold measurements under this Section 2.7.2.1 and will not be eligible for credits under this Section 2.7.2.1 when any of the conditions set forth in Section 2.7.4(B) following exist.

ACCESS SERVICE

- 2. General Regulations (Cont'd)
- 2.7 Service Level Agreements (Cont'd)
- 2.7.2 Enhanced Service Level Agreements (Enhanced SLAs) (Cont'd)
- 2.7.2.2 (Reserved for Future Use)

(X)
|
(X)

(X) Under authority of Special Permission No. 10-XXXX, withdraws material filed under Transmittal No. 11 before it becomes effective and reinstates existing language.

ACCESS SERVICE

- 2. General Regulations (Cont'd)
- 2.7 Service Level Agreements (Cont'd)
- 2.7.2 Enhanced Service Level Agreements (Enhanced SLAs) (Cont'd)
- 2.7.2.3 (Reserved for Future Use) (D)

(D)

ACCESS SERVICE

- 2. General Regulations (Cont'd)
- 2.7 Service Level Agreements (Cont'd)
- 2.7.2 Enhanced Service Level Agreements (Enhanced SLAs) (Cont'd)
- 2.7.2.3 Reserved for Future Use (Cont'd)

(D)

(D)

ACCESS SERVICE

- 2. General Regulations (Cont'd)
- 2.7 Service Level Agreements (Cont'd)
- 2.7.2 Enhanced Service Level Agreements (Enhanced SLAs) (Cont'd)
- 2.7.2.3 Reserved for Future Use (Cont'd)

(D)

(D)

ACCESS SERVICE

- 2. General Regulations (Cont'd)
- 2.7 Service Level Agreements (Cont'd)
- 2.7.2 Enhanced Service Level Agreements (Enhanced SLAs) (Cont'd)
- 2.7.2.3 Reserved for Future Use (Cont'd)

(D)

(D)

ACCESS SERVICE

- 2. General Regulations (Cont'd)
- 2.7 Service Level Agreements (Cont'd)
- 2.7.2 Enhanced Service Level Agreements (Enhanced SLAs) (Cont'd)
- 2.7.2.3 Reserved for Future Use (Cont'd)

(D)

(D)

ACCESS SERVICE

- 2. General Regulations (Cont'd)
- 2.7 Service Level Agreements (Cont'd)
- 2.7.2 Enhanced Service Level Agreements (Enhanced SLAs) (Cont'd)
- 2.7.2.3 Reserved for Future Use (Cont'd)

(D)

(D)

ACCESS SERVICE

- 2. General Regulations (Cont'd)
- 2.7 Service Level Agreements (Cont'd)
- 2.7.2 Enhanced Service Level Agreements (Enhanced SLAs) (Cont'd)
- 2.7.2.3 Reserved for Future Use (Cont'd)

(D)

(D)

ACCESS SERVICE

- 2. General Regulations (Cont'd)
- 2.7 Service Level Agreements (Cont'd)
- 2.7.2 Enhanced Service Level Agreements (Enhanced SLAs) (Cont'd)
- 2.7.2.3 Reserved for Future Use (Cont'd)

(D)

(D)

ACCESS SERVICE

- 2. General Regulations (Cont'd)
- 2.7 Service Level Agreements (Cont'd)
- 2.7.2 Enhanced Service Level Agreements (Enhanced SLAs) (Cont'd)
- 2.7.2.3 Reserved for Future Use (Cont'd)

(D)

(D)

ACCESS SERVICE

- 2. General Regulations (Cont'd)
- 2.7 Service Level Agreements (Cont'd)
- 2.7.2 Enhanced Service Level Agreements (Enhanced SLAs) (Cont'd)
- 2.7.2.3 Reserved for Future Use (Cont'd)

(D)

(D)

ACCESS SERVICE

- 2. General Regulations (Cont'd)
- 2.7 Service Level Agreements (Cont'd)
- 2.7.2 Enhanced Service Level Agreements (Enhanced SLAs) (Cont'd)
- 2.7.2.3 Reserved for Future Use (Cont'd)

(D)

(D)

ACCESS SERVICE

- 2. General Regulations (Cont'd)
- 2.7 Service Level Agreements (Cont'd)
- 2.7.2 Enhanced Service Level Agreements (Enhanced SLAs) (Cont'd)
- 2.7.2.4 Reserved for Future Use

(D)

(D)

ACCESS SERVICE

- 2. General Regulations (Cont'd)
- 2.7 Service Level Agreements (Cont'd)
- 2.7.2 Enhanced Service Level Agreements (Enhanced SLAs) (Cont'd)
- 2.7.2.4 Reserved for Future Use (Cont'd)

(D)

(D)

ACCESS SERVICE

- 2. General Regulations (Cont'd)
- 2.7 Service Level Agreements (Cont'd)
- 2.7.2 Enhanced Service Level Agreements (Enhanced SLAs) (Cont'd)
- 2.7.2.4 Reserved for Future Use (Cont'd)

(D)

(D)

ACCESS SERVICE

- 2. General Regulations (Cont'd)
- 2.7 Service Level Agreements (Cont'd)
- 2.7.2 Enhanced Service Level Agreements (Enhanced SLAs) (Cont'd)
- 2.7.2.4 Reserved for Future Use

(D)

(D)

ACCESS SERVICE

- 2. General Regulations (Cont'd)
- 2.7 Service Level Agreements (Cont'd)
- 2.7.2 Enhanced Service Level Agreements (Enhanced SLAs) (Cont'd)
- 2.7.2.4 Reserved for Future Use (Cont'd)

(D)

(D)

ACCESS SERVICE

- 2. General Regulations (Cont'd)
- 2.7 Service Level Agreements (Cont'd)
- 2.7.2 Enhanced Service Level Agreements (Enhanced SLAs) (Cont'd)
- 2.7.2.4 Reserved for Future Use (Cont'd)

(D)

(D)

ACCESS SERVICE

- 2. General Regulations (Cont'd)
- 2.7 Service Level Agreements (Cont'd)
- 2.7.2 Enhanced Service Level Agreements (Enhanced SLAs) (Cont'd)
- 2.7.2.4 Reserved for Future Use (Cont'd) (D)

(D)

ACCESS SERVICE

- 2. General Regulations (Cont'd)
- 2.7 Service Level Agreements (Cont'd)
- 2.7.2 Enhanced Service Level Agreements (Enhanced SLAs) (Cont'd)
- 2.7.2.4 Reserved for Future Use (Cont'd)

(D)

(D)

ACCESS SERVICE

- 2. General Regulations (Cont'd)
- 2.7 Service Level Agreements (Cont'd)
- 2.7.2 Enhanced Service Level Agreements (Enhanced SLAs) (Cont'd)
- 2.7.2.4 Reserved for Future Use (Cont'd)

(D)

(D)

ACCESS SERVICE

- 2. General Regulations (Cont'd)
- 2.7 Service Level Agreements (Cont'd)
- 2.7.2 Enhanced Service Level Agreements (Enhanced SLAs) (Cont'd)
- 2.7.2.4 Reserved for Future Use (Cont'd)

(D)

(D)

ACCESS SERVICE

- 2. General Regulations (Cont'd)
- 2.7 Service Level Agreements (Cont'd)
- 2.7.2 Enhanced Service Level Agreements (Enhanced SLAs) (Cont'd)
- 2.7.2.4 Reserved for Future Use (Cont'd)

(D)

(D)

ACCESS SERVICE

- 2. General Regulations (Cont'd)
- 2.7 Service Level Agreements (Cont'd)
- 2.7.3 Reserved for Future Use

(D)

(D)

ACCESS SERVICE

- 2. General Regulations (Cont'd)
- 2.7 Service Level Agreements (Cont'd)
- 2.7.3 Reserved for Future Use (Cont'd)

(D)

(D)

ACCESS SERVICE

- 2. General Regulations (Cont'd)
- 2.7 Service Level Agreements (Cont'd)
- 2.7.3 Reserved for Future Use (Cont'd)

(D)

(D)

ACCESS SERVICE

- 2. General Regulations (Cont'd)
- 2.7 Service Level Agreements (Cont'd)
- 2.7.3 Reserved for Future Use (Cont'd)

(D)

(D)

ACCESS SERVICE

- 2. General Regulations (Cont'd)
- 2.7 Service Level Agreements (Cont'd)
- 2.7.3 Reserved for Future Use (Cont'd)

(D)

(D)

ACCESS SERVICE

2. General Regulations (Cont'd)

2.7 Service Level Agreements (Cont'd)

2.7.3 Reserved for Future Use (Cont'd)

(D)

(D)

ACCESS SERVICE

- 2. General Regulations (Cont'd)
- 2.7 Service Level Agreements (Cont'd)
- 2.7.3 Reserved for Future Use (Cont'd)

(D)

(D)

ACCESS SERVICE

- 2. General Regulations (Cont'd)
- 2.7 Service Level Agreements (Cont'd)
- 2.7.3 Reserved for Future Use (Cont'd)

(D)

(D)

ACCESS SERVICE

- 2. General Regulations (Cont'd)
- 2.7 Service Level Agreements (Cont'd)
- 2.7.3 Reserved for Future Use (Cont'd) (D)

(D)

ACCESS SERVICE

- 2. General Regulations (Cont'd)
- 2.7 Service Level Agreements (Cont'd)
- 2.7.3 Reserved for Future Use (Cont'd)

(D)

(D)

ACCESS SERVICE

- 2. General Regulations (Cont'd)
- 2.7.3 Service Level Agreements (Cont'd)
- 2.7.3.1 Reserved for Future Use (Cont'd)

(D)

(D)

ACCESS SERVICE

- 2. General Regulations (Cont'd)
- 2.7 Service Level Agreements (Cont'd)
- 2.7.3 Reserved for Future Use (Cont'd)

(D)

(D)

ACCESS SERVICE

- 2. General Regulations (Cont'd)
- 2.7 Service Level Agreements (Cont'd)
- 2.7.3 Reserved for Future Use (Cont'd)

(D)

(D)

ACCESS SERVICE

- 2. General Regulations (Cont'd)
- 2.7 Service Level Agreements (Cont'd)
- 2.7.3 Reserved for Future Use (Cont'd)

(D)

(D)

ACCESS SERVICE

- 2. General Regulations (Cont'd)
- 2.7 Service Level Agreements (Cont'd)
- 2.7.3 Reserved for Future Use (Cont'd)

(D)

(D)

ACCESS SERVICE

- 2. General Regulations (Cont'd)
- 2.7 Service Level Agreements (Cont'd)
- 2.7.3 Reserved for Future Use (Cont'd)

(D)

(D)

ACCESS SERVICE

- 2. General Regulations (Cont'd)
- 2.7 Service Level Agreements (Cont'd)
- 2.7.3 Reserved for Future Use (Cont'd)

(D)

(D)

ACCESS SERVICE

- 2. General Regulations (Cont'd)
- 2.7 Service Level Agreements (Cont'd)
- 2.7.3 Reserved for Future Use (Cont'd)

(D)

(D)

ACCESS SERVICE

- 2. General Regulations (Cont'd)
- 2.7 Service Level Agreements (Cont'd)
- 2.7.3 Reserved for Future Use (Cont'd)

(D)

(D)

ACCESS SERVICE

- 2. General Regulations (Cont'd)
- 2.7 Service Level Agreements (Cont'd)
- 2.7.3 Reserved for Future Use (Cont'd)

(D)

(D)

ACCESS SERVICE

- 2. General Regulations (Cont'd)
- 2.7 Service Level Agreements (Cont'd)
- 2.7.3 Reserved for Future Use (Cont'd)

(D)

(D)

ACCESS SERVICE

- 2. General Regulations (Cont'd)
- 2.7 Service Level Agreements (Cont'd)
- 2.7.3 Reserved for Future Use (Cont'd)

(D)

(D)

ACCESS SERVICE

2. General Regulations (Cont'd)

2.7 Service Level Agreements (Cont'd)

2.7.3 National Service Level Agreements (National SLAs) (Cont'd)

(D)

(D)

ACCESS SERVICE

- 2. General Regulations (Cont'd)
- 2.7 Service Level Agreements (Cont'd)
- 2.7.3 Reserved for Future Use (Cont'd)

(D)

(D)

ACCESS SERVICE

- 2. General Regulations (Cont'd)
- 2.7 Service Level Agreements (Cont'd)
- 2.7.3 Reserved for Future Use (Cont'd)

(D)

(D)

ACCESS SERVICE

- 2. General Regulations (Cont'd)
- 2.7 Service Level Agreements (Cont'd)
- 2.7.3 Reserved for Future Use (Cont'd)

(D)

(D)

ACCESS SERVICE

- 2. General Regulations (Cont'd)
- 2.7 Service Level Agreements (Cont'd)
- 2.7.4 When a Credit Allowance Does Not Apply
- (A) Reserved for Future Use

(C)

(C)

ACCESS SERVICE

- 2. General Regulations (Cont'd)
- 2.7 Service Level Agreements (Cont'd)
- 2.7.4 When a Credit Allowance Does Not Apply (Cont'd)
- (A) Reserved for Future Use (Cont'd)

(C)

(C)

ACCESS SERVICE

2. General Regulations (Cont'd)**2.7 Service Level Agreements (Cont'd)****2.7.4 When a Credit Allowance Does Not Apply (Cont'd)****(B) Credit Allowance for Interruptions/Mean Time to Restore/Availability**

This Section 2.7.4(B) applies to and supplements Section 2.7.1.1 preceding, Credit Allowance for Service Interruptions; Section 2.7.2 preceding, Enhanced Service Level Agreements; and Section 2.7.3 preceding, National Service Level Agreements. Services will not be included in performance measurements and credits will not apply:

- (1) When the customer fails to report the interruption to the Telephone Company (excluding DS3 Integrated Optical Service Riders); or
- (2) When the interruption was caused by the act or omission of the customer or a party authorized by the customer to use the service; or
- (3) When the interruption was due to the failure of power, equipment, service, or systems provided by the customer or persons other than the Telephone Company; or
- (4) For any period in which the Telephone Company is not afforded access to the premises where the service is terminated; or
- (5) When the customer has released the service to the Telephone Company for maintenance purposes, to make rearrangements, or for the implementation of an order for a change in the service, during the time that was negotiated with the customer prior to the release of that service (thereafter, a credit allowance as set forth in this Section 2.7 applies); or
- (6) For any period of scheduled maintenance or scheduled downtime where the customer has received prior notification from the Telephone Company; or
- (7) When interruptions occur or continue because of the failure of the customer to authorize the replacement of any element of special construction; or

ACCESS SERVICE

2. General Regulations (Cont'd)**2.7 Service Level Agreements (Cont'd)****2.7.4 When a Credit Allowance Does Not Apply (Cont'd)****(B) Credit Allowance for Interruptions/Mean Time to Restore/Availability (Cont'd)**

(8) For periods when the customer elects not to release the service for testing and/or repair; or

(9) For periods of temporary discontinuance as set forth in Section 2.1.8 preceding; or

(10) During periods of interruption as set forth in Section 8.3 following; or

(11) When an interruption is required, permitted or excused by this Tariff, or

(12) For interruptions, failures or delays due to acts of God or the public enemy, compliance with any law or any regulation or order of any governmental authority, acts of terrorism, war, rebellion, insurrection or sabotage or damage resulting there from, fires, floods, earthquakes, volcanic action, unusually severe weather, explosions, washouts, rules and regulations with regard to common carriers, accidents, epidemics, riots, strikes or other concerted acts of employees, whether direct or indirect, lockouts or other industrial disturbances, whether direct or indirect, worms, viruses or other contaminants that may cause damage to or disable software, computer or electronic systems, or any similar cause, or other causes beyond the Telephone Company's reasonable control (except that, this Section 2.7.4(B)(12) does not apply to Section 2.7.1.1, excluding the SASG as set forth in Section 2.7.1.1(B)(5), to which this Section 2.7.4(B)(12) shall apply); or

(13) For an interruption, or a group of interruptions resulting from a common cause, for amounts less than one dollar; or

(14) For any interruption of LAN Extension Service as described in 7.14 following; or

(15) For any interruption of an EIS or EIS elements as described in Section 17 following.

ACCESS SERVICE

2. General Regulations (Cont'd)**2.8 Sale or Transfer of an Operating Telephone Company's Assets and/or Stock to an Unaffiliated Third Party**

This Section 2.8 shall apply: (i) if the Telephone Company sells or transfers all or a portion of the assets or stock of a Frontier Operating Telephone Company (e.g., Frontier Communications of the Southwest Inc.) to an unaffiliated third party ("Transfer"); and (ii) a service offering or Service Level Agreement (SLA) of this tariff as referenced in this Section 2.8 does not include terms and conditions relating to a Transfer.

(T)

2.8.1 General

The terms and conditions set forth in Section 2.8.2 following shall apply:

- (A) when a customer subscribes to a service offering under this tariff that aggregates the customer's purchases from the Telephone Company to measure compliance with such service offering or the customer participates in a SLA that aggregates the customer's measured transactions, and:
- (B) the service offering or SLA does not include terms and conditions pertaining to a Transfer; and
- (C) as a result of the Transfer, one or more of the following conditions occur solely as a result of the Telephone Company no longer providing the same quantity of services:
- (1) the customer no longer satisfies the minimum requirements of the service offering or SLA;
- (2) the customer is subject to a related penalty, termination liability or cancellation;
- (3) the customer is subject to a change in the tier of a volume table or a rate table; and
- (4) the customer is subject to a change in the rate level of the service offering.

2.8.2 Undertaking of the Telephone Company Following a Transfer

When the conditions set forth in 2.8.1 preceding exist, the Telephone Company will utilize the following terms and conditions, as applicable.

- (A) If the service offering includes specific minimum ordering requirements for participation, or requires that the customer achieve a minimum number of services, minimum number of rate elements, and/or minimum revenue within a specific geographic area in order to continue its subscription to the service offering or participation in a pricing plan for such service offering (each, a Minimum Requirement), the Telephone Company will apply the terms and conditions of this Section 2.8.2(A). The following service offerings have Minimum Requirements that are subject to this Section 2.8.2(A).

- Call Management Signaling Service as set forth in Section 8.17.4(B) following
- Banded Optical Transport as set forth in Sections 10.6.1(G) and 20(D)(2)(f) following
- TCP/IP Data Aggregation Service as set forth in Section 18.3 following

ACCESS SERVICE

2. General Regulations (Cont'd)**2.8 Sale or Transfer of an Operating Telephone Company's Assets and/or Stock to an Unaffiliated Third Party (Cont'd)****2.8.2 Undertaking of the Telephone Company Following a Transfer (Cont'd)****(A) (Cont'd)**

In the event of a Transfer, the following applies.

- (1) The Telephone Company will, consistent with the service offering, determine if the customer satisfies the Minimum Requirement for the service offering with the reduced quantity of services the Telephone Company provides to the customer following the Transfer; and
- (2) if the customer does not satisfy the Minimum Requirement following the Transfer, determine if the customer would have satisfied the Minimum Requirement had the Transfer not occurred. If the customer would have satisfied the Minimum Requirement had the Transfer not occurred, then no further action shall be taken and the customer will be considered to have satisfied the Minimum Requirement. If the customer would not have satisfied the Minimum Requirement had the Transfer not occurred, then the terms and conditions for such result shall apply under the applicable service offering, except that the calculation of any penalty associated with not satisfying the Minimum Requirement shall be reduced pro-rata to reflect the Transfer. Upon renewal of the customer's commitment period for such service offering or subsequent subscription to such service offering, as applicable, the terms and conditions set forth in the applicable section(s) of this tariff shall apply, including satisfying the Minimum Requirement for such service offering using only the quantity of services the customer purchases from the Telephone Company at the time of renewal or subsequent subscription.

For example, assume Frontier Communications of the Southwest Inc transfers a portion of its assets to an unaffiliated third party. Further assume that a customer subscribes to Call Management Signaling Service under Section 8.17.4(B) following which has a minimum monthly billing of one million (1,000,000) call signals per month. Also assume that following the Transfer, the volume of call signals recorded for the customer at the next scheduled review is nine hundred fifty thousand (950,000), and that an estimated one hundred thousand (100,000) call signals were associated with the services transferred to the unaffiliated third party. In this case, the Telephone Company would determine if the customer would have satisfied the minimum number of call signals had the Transfer not occurred by adding (i) the estimated number of call signals associated with the services transferred to the unaffiliated third party and; (ii) the recorded number of call signals for the period of review [950,000 + 100,000 = 1,050,000 call signals]. Based on this calculation, the customer would have satisfied the Minimum Requirement and will not incur any shortfall charges. However, if the result of such calculation was that the customer still did not satisfy the Minimum Requirement for the service, then the terms and conditions for such result shall apply under Section 8.17.4(B) following, except that the calculation of shortfall charges shall be reduced pro-rata to reflect the Transfer

(T)

ACCESS SERVICE

2. General Regulations (Cont'd)**2.8 Sale or Transfer of an Operating Telephone Company's Assets and/or Stock to an Unaffiliated Third Party (Cont'd)****2.8.2 Undertaking of the Telephone Company Following a Transfer (Cont'd)**

(B) If the service offering requires that the customer commit a minimum number of the services or rate elements that the customer purchases from the Telephone Company and maintain such minimum during the term of the service offering (a Commitment Level), and the service offering does not apply rates or credits based on a volume based tier structure, the Telephone Company will apply this Section 2.8.2(B). The following service offering has a Commitment Level that is subject to this Section 2.8.2(B).

- DS1 Term Payment Plan as set forth in Section 7.2.1(G) following

In the event of a Transfer, the following applies.

- (1) The Telephone Company will recalculate the Commitment Level for the duration of the current term to reflect the removal of the services the Telephone Company no longer provides to the customer solely as a result of the Transfer; and
- (2) use the reduced Commitment Level in all subsequent reviews/true-ups that measure the customer's compliance with established requirements for the service offering for the balance of the current term unless otherwise revised by: (i) the customer in accordance with the terms and conditions of the service offering; or (ii) the terms and conditions of such service offering. Upon renewal of the customer's term for such service offering, the terms and conditions set forth in the applicable section(s) of this tariff shall apply, including establishment of a new Commitment Level using only the quantity of services the customer purchases from the Telephone Company at the time of renewal.

(C) For example, assume Frontier Communications of the Southwest Inc. transfers a portion of its assets to an unaffiliated third party. Further assume a customer with a DS1 Term Payment Plan and a Commitment Level of seventy-five (75) DS1 SALs is ten (10) DS1 SALs short of its Commitment Level at the next scheduled annual review (i.e., the customer has sixty-five (65) in-service DS1 SALs at the annual review). Also assume that ten (10) DS1 SALs were transferred to an unaffiliated third party as a result of the Transfer. In this case, the Telephone Company will reduce the customer's Commitment Level to sixty-five (65) DS1 SALs to reflect the Transfer. Since the customer has satisfied its reduced Commitment Level, no further action applies and the customer will not incur any penalty for such result during the annual review. (T)

For Service Level Agreements (SLAs), a customer who participates in one of such SLAs prior to a Transfer shall continue with such SLA for the balance of the subscription term, regardless of whether or not the customer is able to satisfy the minimum requirement(s) of the SLA using the reduced quantity of services the Telephone Company provides to the customer following a Transfer. The following SLAs are subject to this Section 2.8.2(D):

- 2010 Enhanced Service Level Agreement as set forth in Section 2.7.2.4 preceding

- 2010 National Service Level Agreement as set forth in Section 2.7.3.2 preceding

For example, assume Frontier Communications of the Southwest Inc transfers a portion of its assets to an unaffiliated third party. Further assume that a customer subscribes to the 2010 Enhanced SLA Plan for Qualifying Services under Section 2.7.2.4 preceding. The 2010 Enhanced SLA Plan for Qualifying Services requires that the customer have at least thirty-five (35) measured transactions per month as a condition for participation in such SLA. Finally, assume that immediately following the Transfer, the customer has only twenty-two (22) measured transactions. In this case, the customer will be allowed to continue its subscription to the 2010 Enhanced Service Level Agreement for the remainder of the subscription term ending December 31, 2010. (T)

ACCESS SERVICE

2. General Regulations (Cont'd)**2.9 Initial Transfer of Assets from Predecessor Company**

The original issuing carriers of this tariff were created by a transfer of assets from an unaffiliated third party. This Section 2.9 governs treatment of customers who, at the time of the transfer of assets from the predecessor company, subscribed to a service offering under this tariff that aggregates the customer's purchases from the Telephone Company to measure compliance with such service offering or participated in a SLC that aggregates the customer's measured transactions.

(A) When a customer subscribes to a service offering under this tariff that aggregates the customer's purchases from the Telephone Company to measure compliance with such service offering or the customer participates in a SLA that aggregates the customer's measured transactions, and the service offering or SLA includes terms and conditions pertaining to a transfer, the terms and conditions pertaining to a transfer will apply to that service offering or SLA as if the Telephone Company were the predecessor company.

(B) When customer subscribes to a service offering under this tariff that aggregates the customer's purchases from the Telephone Company to measure compliance with such service offering or the customer participates in a SLA that aggregates the customer's measured transactions, and the service offering or SLA does not include terms and conditions pertaining to a Transfer, Sections 2.8 preceding will apply as if the Telephone Company were the predecessor company.

For example, if a customer subscribed to a service offering with the predecessor company that aggregates the customer's measured transactions, and the transfer of assets resulted in the customer meeting the conditions described in 2.8.1(B) and (C) preceding with respect to the assets transferred to the Telephone Company, the provisions of 289.2 preceding will apply with respect to prorating any Minimum Requirements.

(N)

(N)